



**GENERAL SURGERY
INSTRUMENTS**



CATALOGUE

SOUTH INDIA SURGICAL CO. LTD.

SOUTH INDIA SURGICAL CO.LTD., popularly called as **SISCO**, is engaged in manufacturing of qualitative Surgical Instruments for last 6 decades. It has acquired a frontline position in Health Care Industry, particularly in Surgical Industry.

SISCO is the firm believer of the Principle that “behind every successful surgery an experienced hand along with appropriate tool is pre - requisite and significance of both are inseparable”.

Maintaining consistency in the quality is the prima facie for **SISCO**. It also undertakes modification and alteration of the Instruments according to the need of Surgeons. The R & D dept. Always attenuates its facilities for any suggestion / ideas.

SISCO manufactures extensive range of Surgical Instruments from **General Surgery, Cardio - Thoracic, Neuro, Urology, Plastic, Obstetrics and Gynaecology, Tungsten Carbide, ENT, Minimal Invasive Instruments**. **SISCO** envisages its market trend under backdrop of Shushruta's Culture.

These Surgical Instruments are formed out of Japanese Steel under the surveillance of qualified technicians. These Surgical Instruments are made of 4 series AISI 410 & AISI 420 steel, which is composite of carbon and chrome, providing more hardness to the Instruments, causing spring action and augmenting the life Instruments.

The strength of **SISCO** also lies in maintaining its quality, setting standards, uniqueness in its products, Centralised Marketing Systems, full fledged marketing Network, wide accessibility through Branches, Resident Representatives and last but not the least with its dealer Network.

For preserving consistency in the quality **SISCO** has been awarded **ISO 9001 : 2008 ISO 13485 : 2003** and its products are **CE Certified**.

12 Year ago **SISCO** started its full - fledged production of Disposables Syringes and Foley Catheter and has proved its significance notably. **SISCO**'s success story is not restricted only to in INDIA but has also proven about its quality worldwide by exporting the catheter to more than 40 countries.



Manufacturing Standard

- * ISO 9001 : 2008
- * ISO 13485 : 2003
- * CE Marked
- * DIN Standards
- * ISI Standards



Surgical Instruments Advantages

Wide Range of Instruments

SISCO Manufactures a wide range of Surgical Instruments to cater to the requirements of various surgeons. All Instruments are designed as per International Standards.

Wide Range of Catalogues

Cardio Thoracic, Gynaecology, Urology, Neurology, Tungsten Carbide, Plastic, Obstetrics, ENT, Minimal Invasive Instruments.

Clear markings

All Instruments are laser marked with respective code numbers and Batch Coded for easy and speedy identification.

Laser Marked

To avoid Duplicate Instruments

High Quality Steel

High Quality Imported steel used in Manufacture of Surgical Instruments for long life and durable inbuilt quality.

Warranty

2 years Warranty for Every Surgical Instruments.



Maintenance and care of Instruments

A very large proportion of Surgical Instruments manufactured today are of stainless steel of the appropriate grade. Though it has definite advantages there is a lot of misconceptions and wrong perception about the very word “Stainless Steel”. As a user you may have come across problems with your “Stainless Steel” Instruments Viz. CORROSION, PITTING, SPOTTING, STAINING ETC. Our Ready Reckoner in the following page will answer Cause and Solution to most of these problems.

Apart from “Technical” problems there are various other reason due to which the life of a surgical Instrument is substantially reduced. A little more care at the user end would go a long way in ensuring that an instrument remains as good as new even after years of use. Our guidelines on maintenance is simple to follow and easy to implement in your organization.

It is possible that you have a problem that is different from those identified by us being most common. We would only be happy to hear from you and offer our recommendations.



To Contact

New No: 117, Old No: 65, Wallajah Road, Chennai - 600 002. INDIA.

Ph: +91 - 44 - 42195555 / 28413901 / 902 / 903 / 904 Fax : +91 - 44 - 43227993 / 43227994

e-mail: sisco@sisco.in website: www.sisco.in



**GENERAL SURGERY
INSTRUMENTS**

SISCO



Scalpel Handles

BP HANDLE NO 3
To Fit Blade 10 - 15
BBP 103

BP HANDLE NO 7
To Fit Blade 10 - 15
BBP 107

BP HANDLE NO 3L
Large
To Fit Blade 10 - 15
BBP 103L

BP HANDLE
Bayonet
To Fit Blade 10 - 15
BBP 130



BBP 103

BBP 107

BBP 103L

BBP 130



BP HANDLE NO 4
To Fit Blade 18 - 25

BBP 104

BP HANDLE NO 4L
To Fit Blade 18 - 25

BBP 104L

BP HANDLE
To Fit Blade 18 - 25

BBP 108



BBP 104

BBP 104L

BBP 108



Abdominal Retractors

BALFOUR RETRACTOR
Lateral Blade 58mm Deep
Centre Blade 45 X 80mm
BAR 610

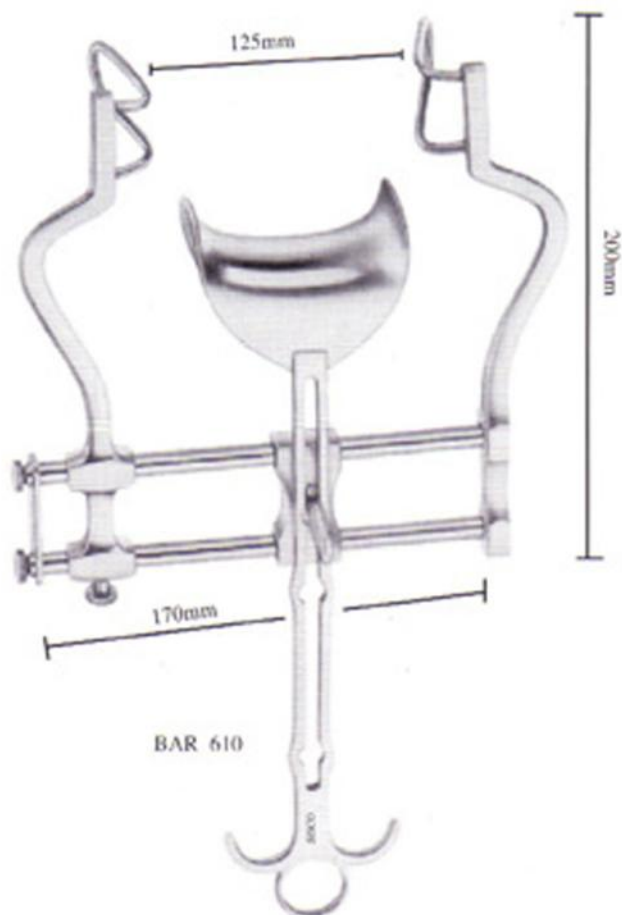

BALFOUR RETRACTOR
Lateral Blade 60mm Deep
Centre Blade 60 X 80mm
BAR 608

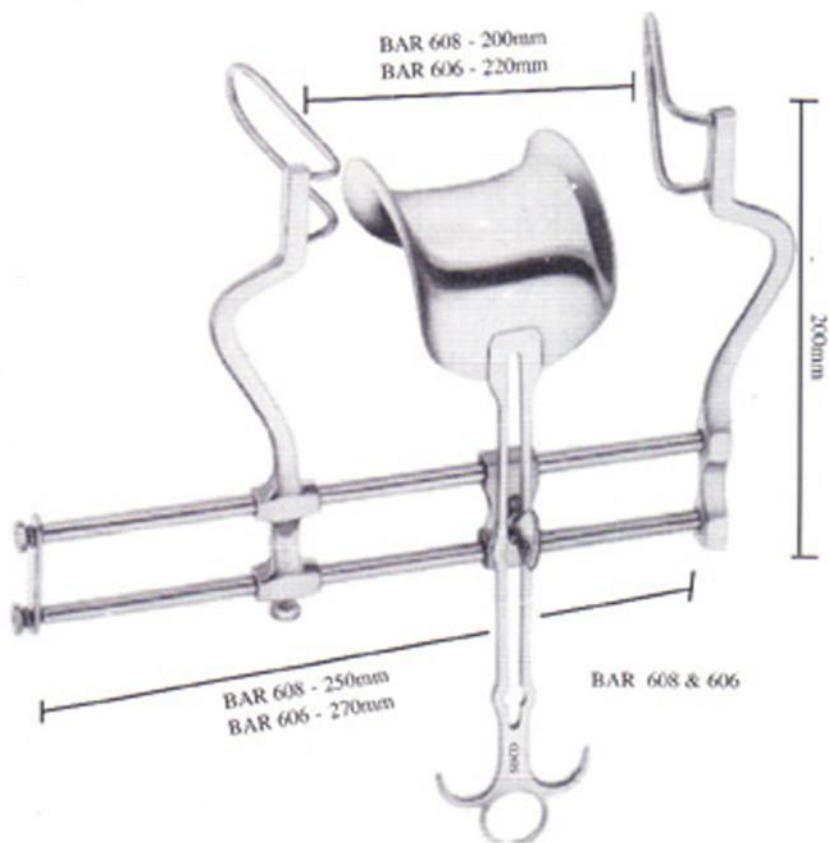

BALFOUR RETRACTOR
Lateral Blade 90mm Deep
Centre Blade 80 X 80mm
BAR 606



Abdominal Retractors

BABY BALFOUR
Lateral Blade 27mm Deep
Centre Blade 21 X 24mm
BAR 602

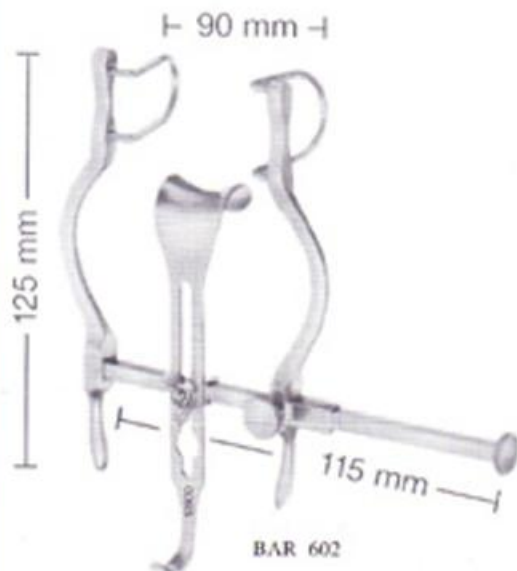

GOSSET BABY
Lateral Blade 40mm Deep
Opening 110mm
BAR 615



GOSSET
Lateral Blade 58mm Deep
Centre Blade 60 X 57mm
BAR 620

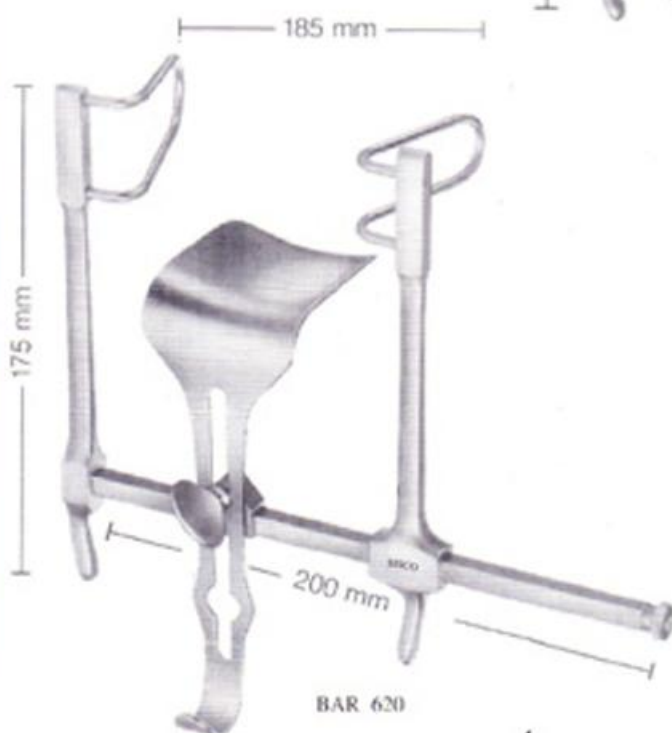



Abdominal Retractors

DENIS - BROWNE

Universal

2 Valve Blades 40 X 30mm

2 Valve Blades 40 X 40mm

Frame 180 X 140mm

BAR 625



BAR 625

DENIS - BROWNE

Universal

2 Valve Blades 40 X 30mm

2 Valve Blades 40 X 40mm

Frame 250 X 180mm

BAR 630



BAR 630



Abdominal Retractors

BABY COLLIN
With 4 Blades
2 Blades 42 X 28mm
2 Blades 42 X 18mm
Opening 80mm
BAR 640

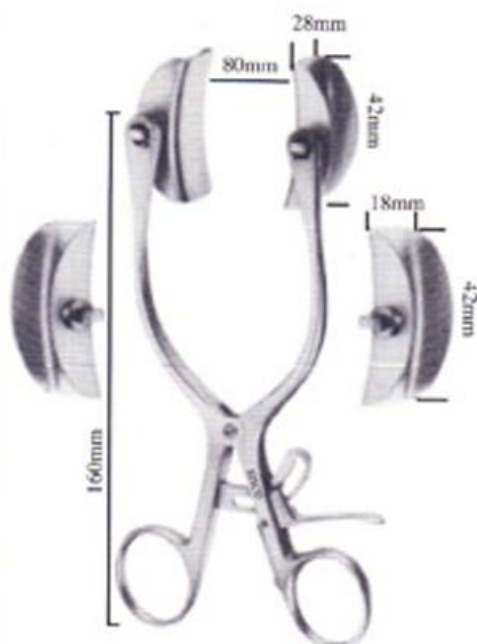

BAR 640

COLLIN
Opening 98mm
Blade 38 X 62mm
BAR 641



BAR 641

POZZI
Triple Bladed
Lateral Blade 38 X 80mm
Centre Blade 55 X 65mm
Opening 120mm
BAR 642



BAR 642

GELPI
Length 180mm
BAR 646

GELPI
Length 135mm
BAR 645



BAR 645 & 646



Bladder Retractors

THOMPSON-WALKER BLADDER RETRACTOR With Four Lateral Blades One Centre Blade

Lateral Blades

24 x 75mm (1 Pair)

24 x 70mm (1 Pair)

Center Blade

25 x 90mm

BSR 650

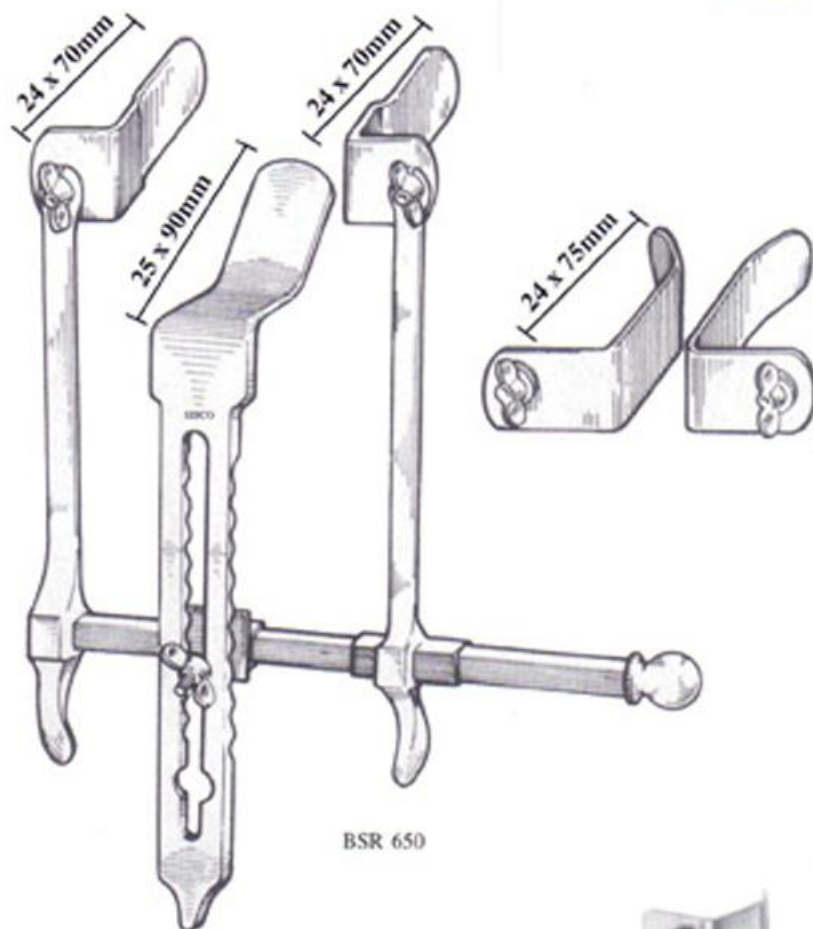

BSR 650

MILLIN Bladder Retractor Two Lateral Blades

55 X 25mm

Two Lateral Blades

80 X 25mm

Centre Blade

115 X 44mm

BSR 660

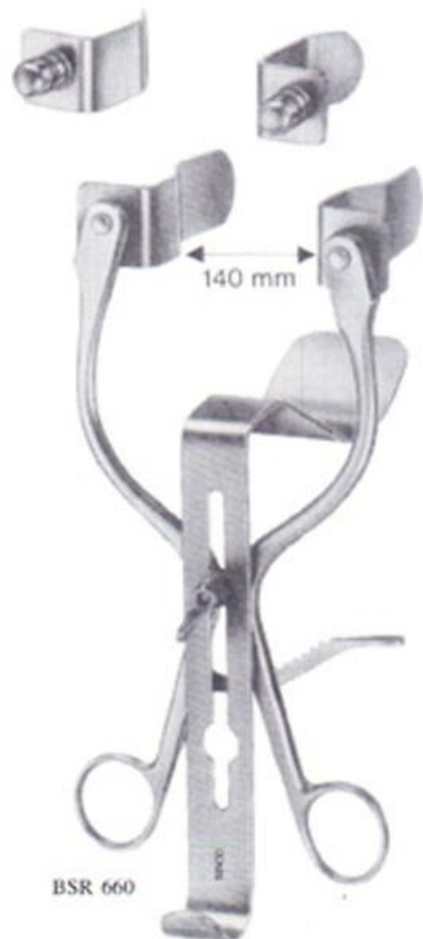

BSR 660



Self-Retaining Retractors

ALM
Retractor
4 X 4 Prongs
Length 100mm
BSR 670

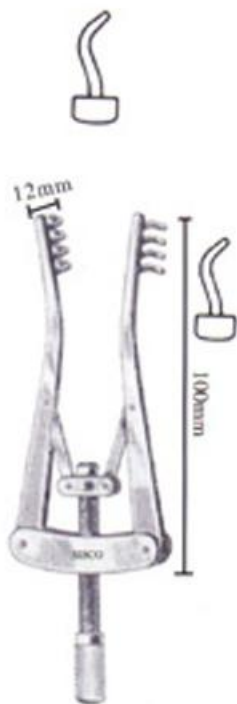

BSR 670

JANSEN
Retractor, Blunt
3 X 3 Prongs
Length 105mm
BSR 672



BSR 672



BSR 672S

JANSEN
Retractor, Sharp
3 X 3 Prongs
Length 105mm
BSR 672S

JANSEN
Retractor
4 X 4 Prongs
Length 115mm
BSR 673 - Blunt
BSR 673S - Sharp



BSR 673



BSR 073

WEISLANDER
Retractor, Blunt
2 X 3 Prongs
Length 105mm
BSR 073



Self-Retaining Retractors

MOLLISON
Retractor, Sharp
4 X 4 Prongs
Length 150mm
BSR 678

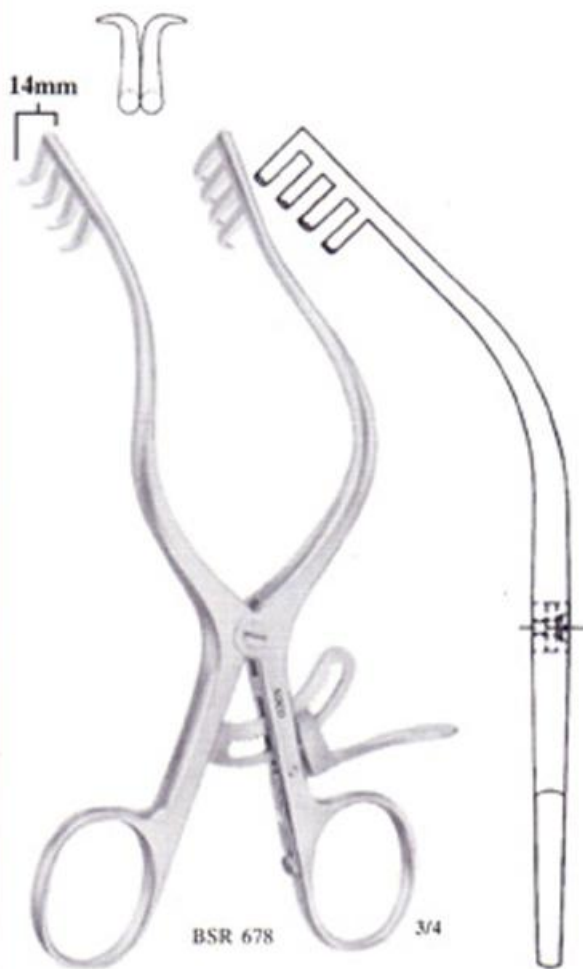

ADSON - BABY
Retractor, Blunt
4 X 3 Prongs
Length 145mm
BSR 676

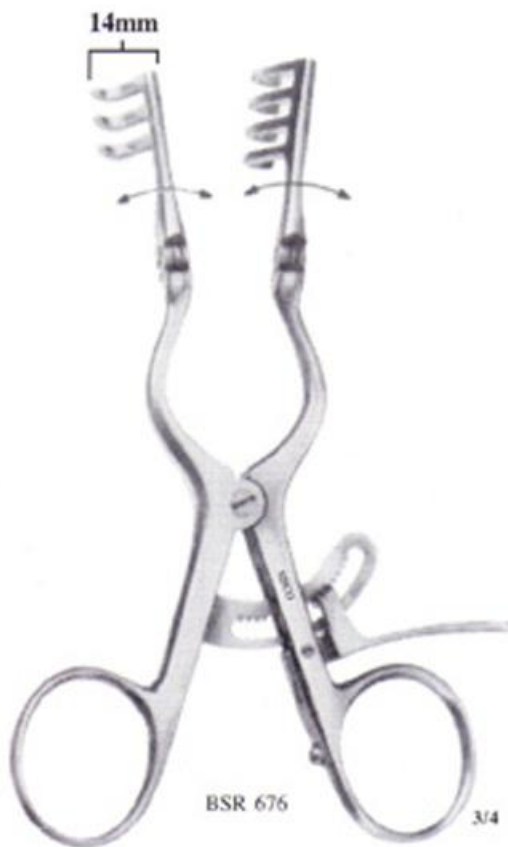

PLESTER
Retractor, Blunt
Left
Length 110mm
BSR 190

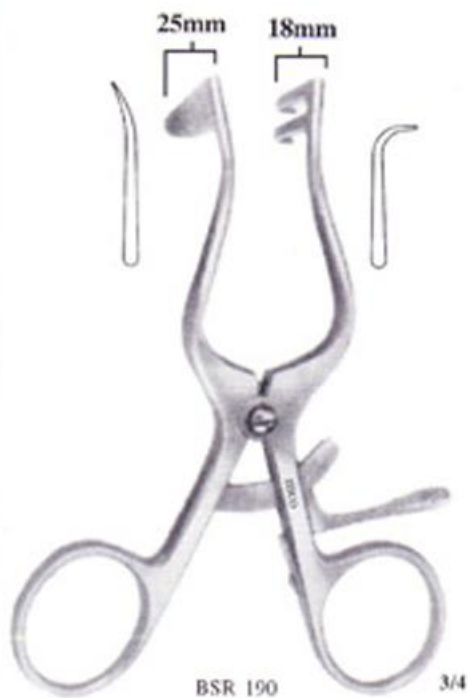

PLESTER
Retractor, Blunt
Right
Length 110mm
BSR 191

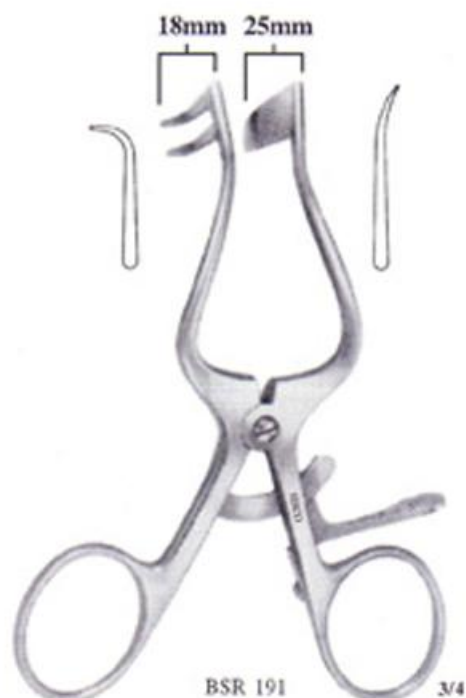



Self-Retaining Retractors

JEFFERSON
Retractor, Blunt
3 X 4 Prongs
Length 140mm
BSR 154

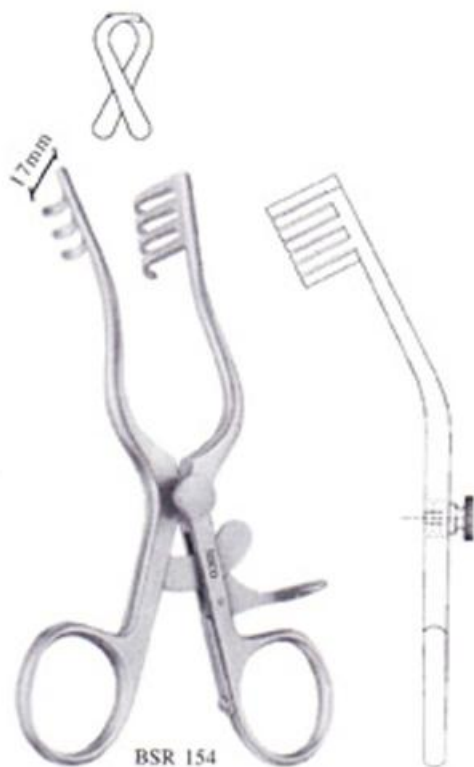

WEISLANDER
Retractor, Blunt
3 X 4 Prongs
Length 165mm
BSR 675



WEISLANDER
Retractor, Sharp
3 X 4 Prongs
Length 165mm
BSR 675S



ANDERSON ADSON
Retractor, Sharp
4 X 4 Prongs
Length 195mm
BSR 674



ADSON
Retractor, Sharp
3 X 4 Prongs
Length 265mm
BSR 677



Self-Retaining Retractors

BECKMANN - ADSON
Retractor, Sharp
4 X 4 Prongs
Length 310mm
BSR 680S



BECKMANN - ADSON
Retractor, Blunt
4 X 4 Prongs
Length 310mm
BSR 680

ADSON
Retractor
5 X 4 Prongs
Length 320mm
BSR 682 - Blunt
BSR 682S - Sharp



Self-Retaining Retractors

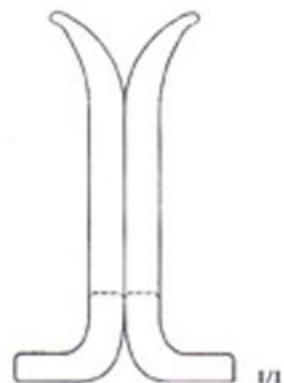
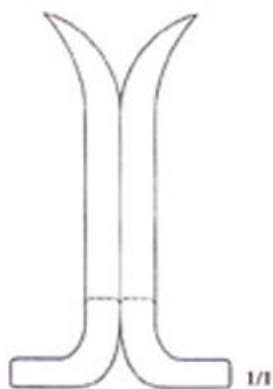

BECKMANN-EATON
Retractor, Sharp
7 X 7 Prongs
Length 320mm
BSR 685S



BECKMANN-EATON
Retractor, Blunt
7 X 7 Prongs
Length 320mm
BSR 685





CLOWARD
Retractor
Set of 10 Blades
250mm
BSR 690



Self-Retaining Retractors

Sharp



40mm

1/2



45mm

1/2



50mm

1/2



55mm

1/2



60mm

1/2

Blunt



40mm

1/2



45mm

1/2



50mm

1/2



55mm

1/2



60mm

1/2



GILLIES
Skin Hook
185mm

BHO 700 - Small

BHO 700L - Large

KILNER
Skin Hook Detachable
185mm

BHO 705

FISCH
Nerve Hook, Sharp
185mm

BHO 710S

FISCH
Nerve Hook, Blunt
185mm

BHO 710





Retractors

SINGLE HOOK Retractor 160mm

BRT 712S - Sharp
BRT 712 - Blunt



DOUBLE HOOK Retractor 160mm

BRT 714S - Sharp
BRT 714 - Blunt

KILNER ALAE Skin Retractor 80mm

BRT 716S - Sharp
BRT 716 - Blunt

30 x 18mm



BRT 720 3/4

25 X 10mm

HAJEK CHEEK Retractor 165mm

BRT 720

MEYER DING Retractor 180mm

BRT 723

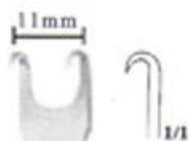

1/1
BRT 716S



BRT 723

3/4



Retractors

SENN MILER
Skin Retractor
165mm
BRT 721



FLEXIBLE HOOK
Retractor, Blunt
160mm
BRT 725 - 727



FLEXIBLE HOOK
Retractor, Sharp
160mm
BRT 725S - 727S



Retractors

VOLKMANN Retractor, Sharp 220mm

- BRT 800S - 2 Prongs
- BRT 801S - 3 Prongs
- BRT 802S - 4 Prongs
- BRT 803S - 6 Prongs
- BRT 804S - 8 Prongs

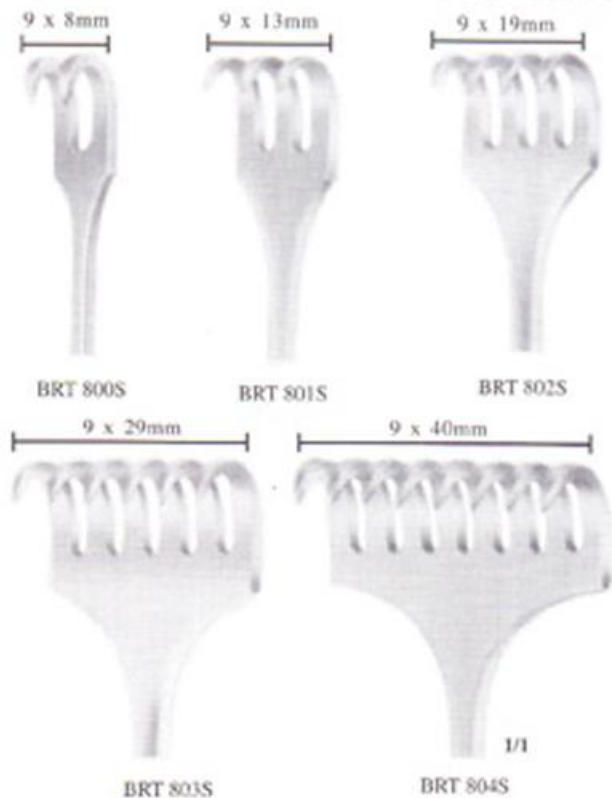

VOLKMANN Retractor, Blunt 220mm

- BRT 800 - 2 Prongs
- BRT 801 - 3 Prongs
- BRT 802 - 4 Prongs
- BRT 803 - 6 Prongs
- BRT 804 - 8 Prongs

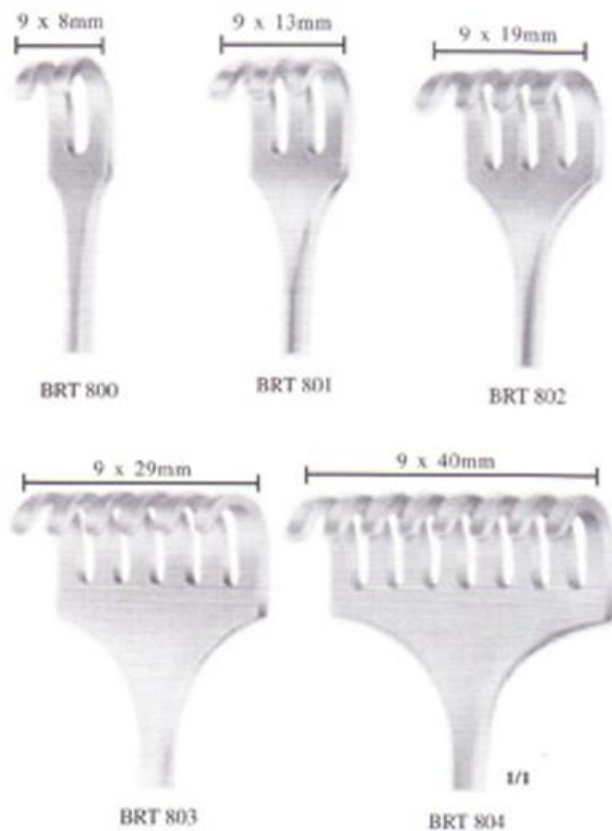



ROUX
Retractor, Set of Three
165mm

BRT 738
19 X 22mm, 23 X 30mm

BRT 739
25 X 26mm, 28 X 38mm

BRT 740
28 X 29mm, 33 X 45mm

FARABEUF
Retractor, Set of Two
150mm

BRT 742
20 X 16mm, 24 X 16mm

BRT 743
23 X 16mm, 28 X 16mm

PARKER
Retractor, Set of Two
150mm

BRT 744
18 X 15mm, 18 X 15mm

BRT 745
22 X 15mm, 22 X 15mm

PARKER LANGENBECK
Retractor, Set of Two
220mm

BRT 746
25 X 15mm, 38 X 15mm

BRT 747
28 X 15mm, 42 X 15mm

CZERNY
Retractor
175mm

BRT 750
38 X 22mm, 38 X 22mm



BRT 738 - 740

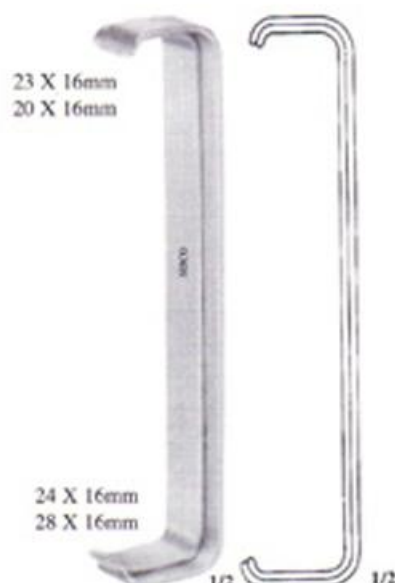

BRT 742 - 743

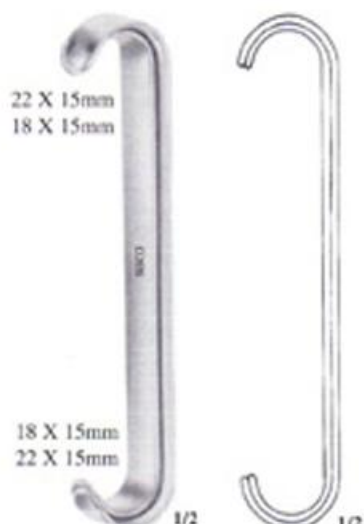

BRT 744 - 745



BRT 746 - 747

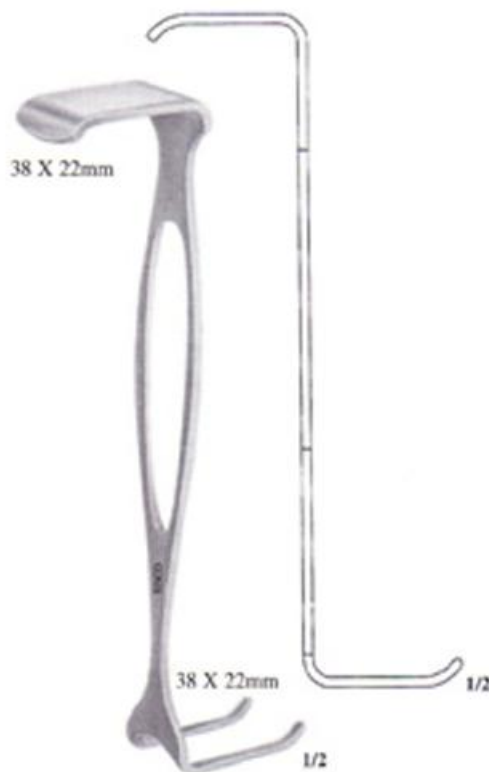

BRT 750



Retractors

LANGENBECK Retractor 215mm

- BRT 752 - 25 X 6mm
- BRT 753 - 35 X 15mm
- BRT 754 - 40 X 11mm
- BRT 755 - 65 X 25mm
- BRT 756 - 90 X 20mm
- BRT 852 - 55 X 22mm
- BRT 853 - 70 X 15mm
- BRT 854 - 30 X 10mm
- BRT 856 - 55 X 11mm
- BRT 862 - 80 X 16mm
- BRT 863 - 40 X 13mm



1/1



25 X 6mm
BRT 752

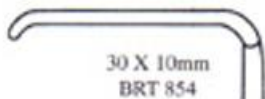

30 X 10mm
BRT 854

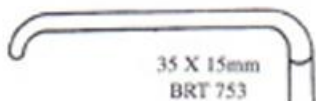

35 X 15mm
BRT 753

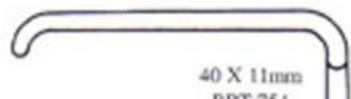

40 X 11mm
BRT 754

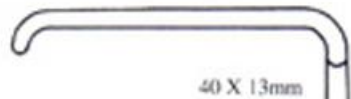

40 X 13mm
BRT 863



55 X 11mm
BRT 856



55 X 22mm
BRT 852



65 X 25mm
BRT 755

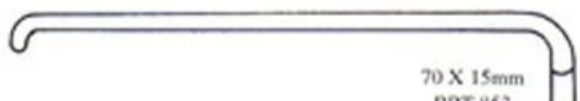

70 X 15mm
BRT 853



80 X 16mm
BRT 862



90 X 20mm
BRT 756



Retractors

KOCHERS
Retractor
36 x 20mm
230mm
BRT 758



KOCHERS
Retractor
67 x 25mm
250mm
BRT 759

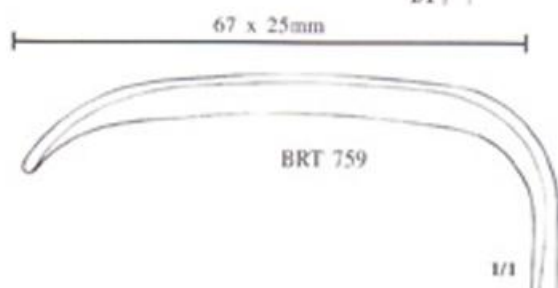

RICHARDSON
Retractor
240mm

BRT 748 - 25 X 20mm
BRT 749 - 30 X 28mm
BRT 749A - 38 X 37mm

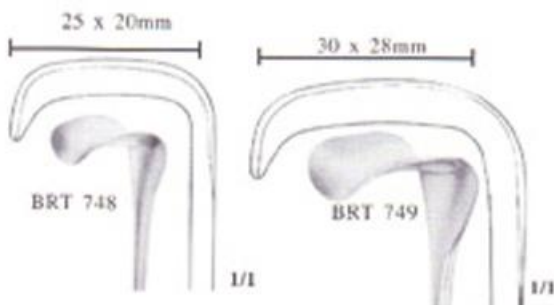

RICHARDSON
Retractor
240mm
47 X 21mm
BRT 478

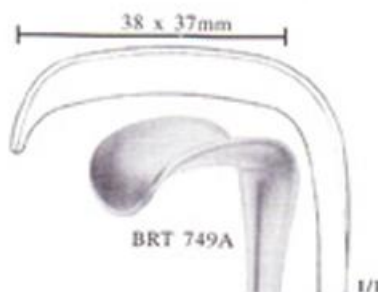

BRT 748-749A

BRT 478



LANDONS VAGINAL

Retractor
89 x 25mm - 200mm
BRT 757



BRT 757



BRT 762

JOLLS TWIN CLAMP

(Friedman)
Retractor
155mm
BRT 762

JOLLS THYROID

Retractor
230mm
BRT 763



BRT 763



BRT 765 - 7 67



BRT 770 - 772

DOYENS

Retractor
230mm
BRT 765 - 30 X 40mm
BRT 766 - 40 X 60mm
BRT 767 - 65 X 85mm

MORRIS

Retractor
230mm
BRT 770 - 30 X 40mm
BRT 771 - 35 X 50mm
BRT 772 - 65 X 65mm

**KELLYS
Retractor
260mm**

BRT 780 - 38mm

BRT 781 - 55mm

BRT 782 - 75mm

**RANGABASHYAM
Vagotomy Retractor
300mm**

BRT 788





DEAVERS

Retractor, Adult
300mm

- BRT 790 - 12mm
- BRT 791 - 15mm
- BRT 792 - 25mm
- BRT 793 - 38mm
- BRT 794 - 50mm
- BRT 795 - 75mm

DEAVERS

Retractor, Child
180mm

- BRT 785 - 20mm

DEAVERS

Retractor, Child
215mm

- BRT 786 - 22mm

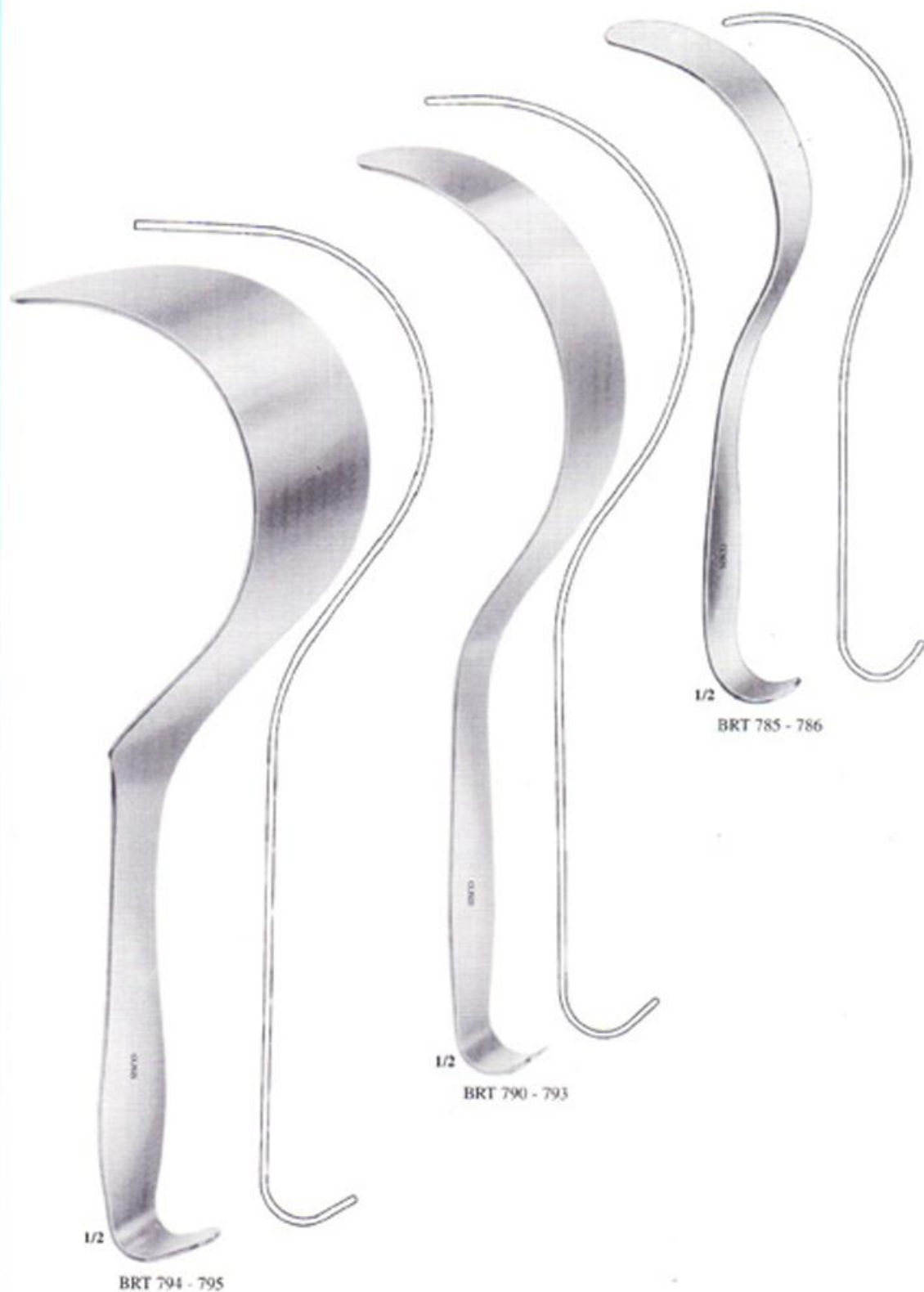



Haemostatic Forceps

HALSTED MOSQUITO

Forceps
125mm

BHF 10 - Straight
BHF 10C - Curved



CRILES

Forceps
Straight
BHF 12 - 140mm
BHF 21 - 160mm

Curved
BHF 12C - 140mm
BHF 21C - 160mm

KELLYS

Forceps, Half Serration
Straight
BHF 13 - 140mm
BHF 22 - 160mm

Curved
BHF 13C - 140mm
BHF 22C - 160mm

SPENCER WELLS

Forceps
Straight
BHF 15 - 125mm
BHF 16 - 150mm
BHF 17 - 180mm
BHF 18 - 200mm
BHF 19 - 230mm
BHF 20 - 250mm

SPENCER WELLS

Forceps
Curved
BHF 15C - 125mm
BHF 16C - 150mm
BHF 17C - 180mm
BHF 18C - 200mm
BHF 19C - 230mm
BHF 20C - 250mm

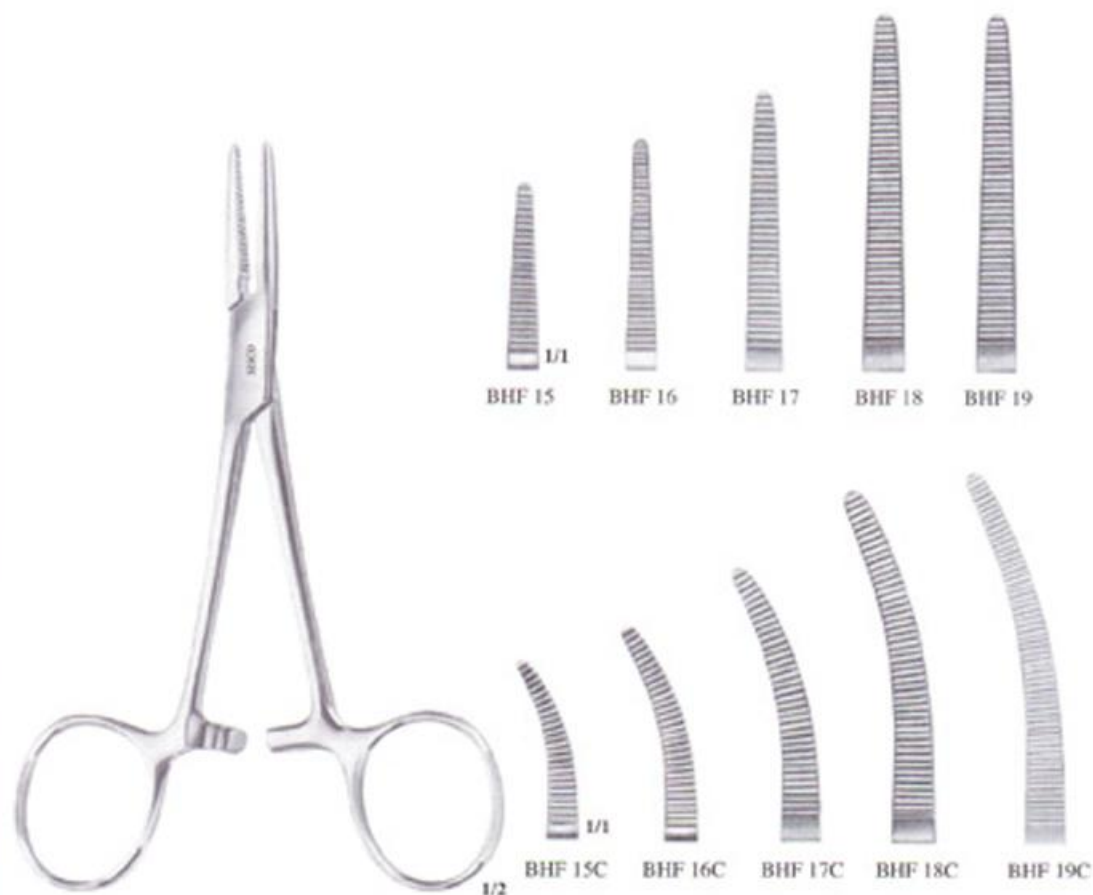



Haemostatic Forceps

PEANS Forceps

Straight

BHF 26 - 150mm

BHF 27 - 180mm

BHF 28 - 200mm

BHF 29 - 230mm

BHF 30 - 250mm

PEANS Forceps

Curved

BHF 26C - 150mm

BHF 27C - 180mm

BHF 28C - 200mm

BHF 29C - 230mm

BHF 30C - 250mm

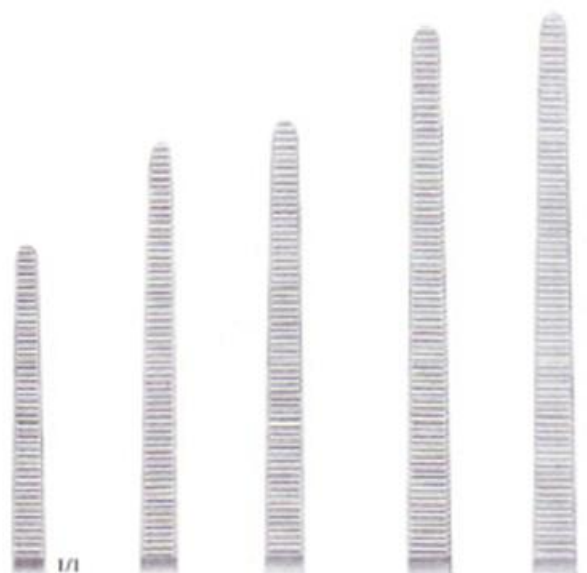

BHF 26

BHF 27

BHF 28

BHF 29

BHF 30



BHF 26

1/1

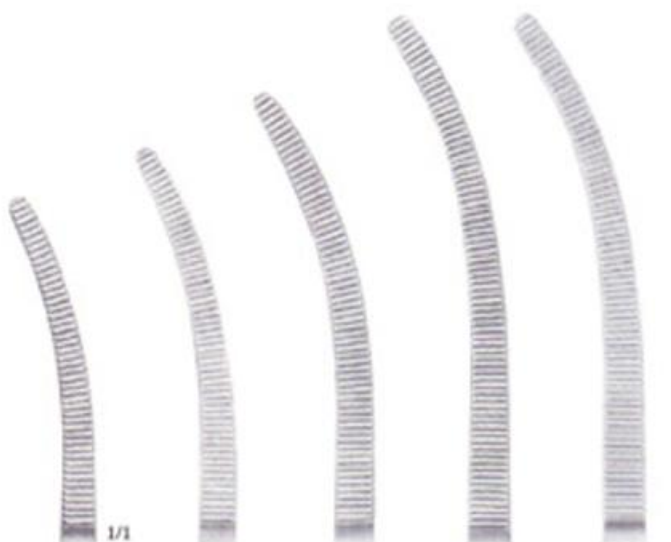

BHF 26C

BHF 27C

BHF 28C

BHF 29C

BHF 30C



Haemostatic Forceps

KOCHERS Forceps

Straight

- BHF 35 - 125mm
- BHF 36 - 150mm
- BHF 37 - 180mm
- BHF 38 - 200mm
- BHF 39 - 230mm
- BHF 40 - 250mm

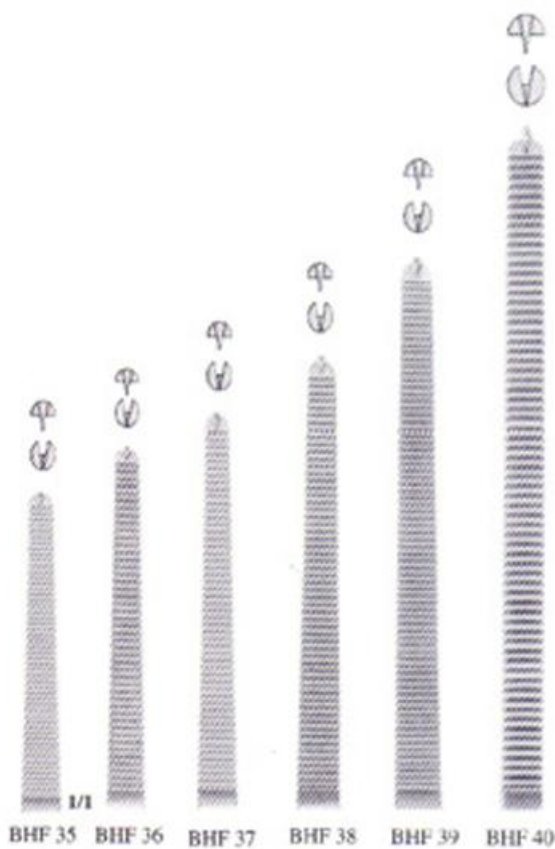
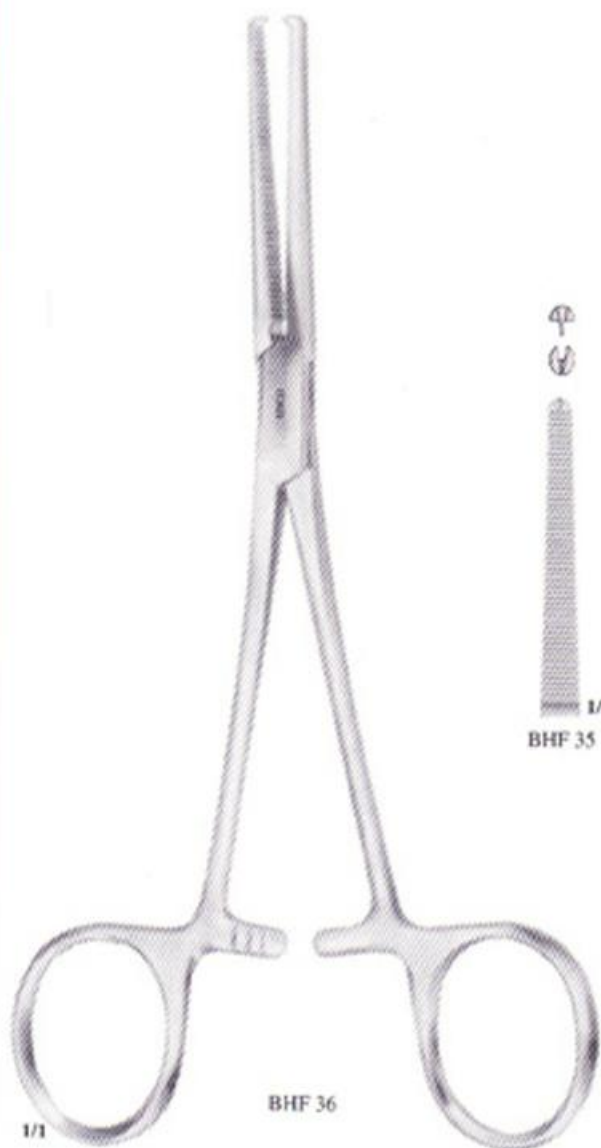

BHF 35 BHF 36 BHF 37 BHF 38 BHF 39 BHF 40

KOCHERS Forceps

Curved

- BHF 35C - 125mm
- BHF 36C - 150mm
- BHF 37C - 180mm
- BHF 38C - 200mm
- BHF 39C - 230mm
- BHF 40C - 250mm

1/1

BHF 36



BHF 35C BHF 36C BHF 37C BHF 38C BHF 39C BHF 40C



Haemostatic Forceps

ROBERTS

Forceps

245mm

BHF 45 - Straight

BHF 45C - Curved



BHF 45

BHF 45C 1/1



BHF 47

BHF 47C 1/1

ADSONS

Forceps

180mm

BHF 47 - Straight

BHF 47C - Curved



BHF 48

BHF 48C 1/1

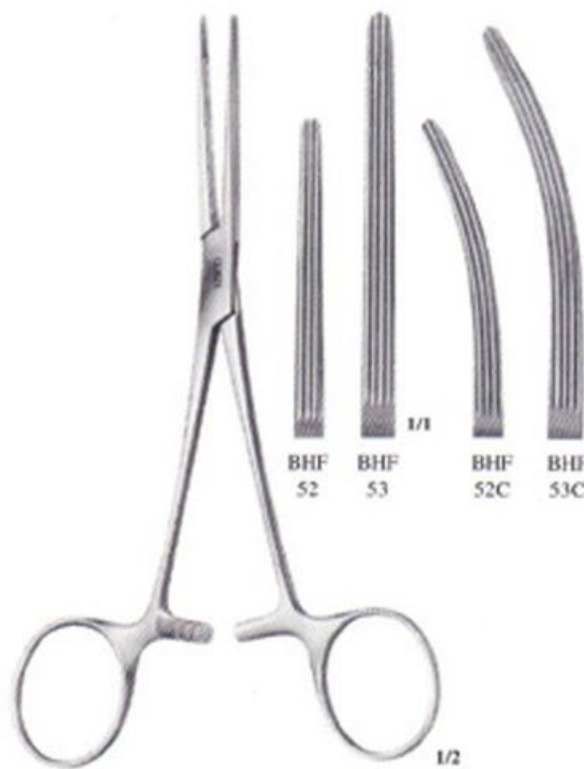

BHF 52

BHF 53 1/1

BHF 52C

BHF 53C

CARMALTS

Forceps

150mm

BHF 52 - Straight

BHF 52C - Curved

200mm

BHF 53 - Straight

BHF 53C - Curved



Haemostatic & Ligature Forceps

CRAFOORD

Forceps

245mm

BHF 50

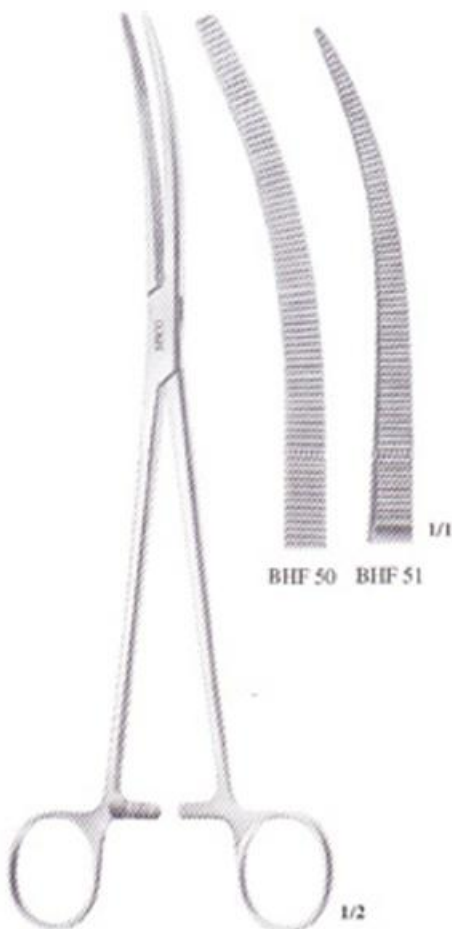

BHF 50 BHF 51

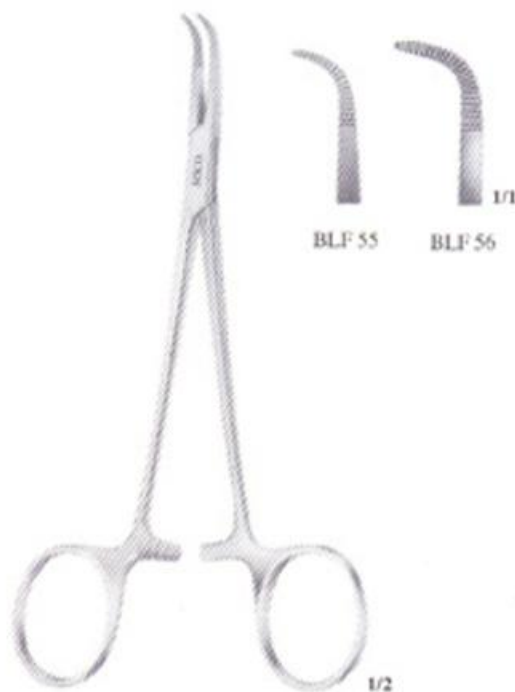

BLF 55 BLF 56

CRAFOORD

Forceps, Fine

245mm

BHF 51

MIXTERS

Ligature Forceps

BLF 55 - 140mm

BLF 56 - 185mm

MIXTERS

Ligature Forceps

BLF 57 - 200mm

BLF 58 - 230mm



BLF 57 - 58

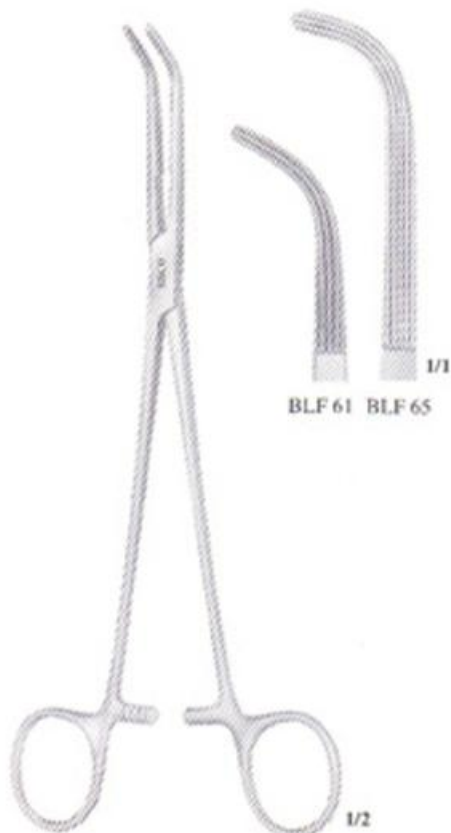

BLF 61 BLF 65

LAHEYS

Ligature Forceps

BLF 61 - 150mm

BLF 62 - 200mm

BLF 63 - 220mm

BLF 64 - 180mm

BLF 65 - 230mm



Hysterectomy Forceps

HEANYS
Hysterectomy Forceps
Single Toothed
200mm

BHY 70T



HEANYS
Hysterectomy Forceps
Doubled Toothed
200mm

BHY 72T



GWILLIAMS
Hysterectomy Forceps
Straight
200mm

BHY 74T



GWILLIAMS
Hysterectomy Forceps
Curved
200mm

BHY 73T



MAINGOTS
Hysterectomy Forceps
Straight
200mm

BHY 76T



MAINGOTS
Hysterectomy Forceps
Curved
200mm

BHY 75T





Dressing Forceps

LISTER SINUS Dressing Forceps

BFD 80 - 160mm
BFD 81 - 180mm
BFD 79 - 200mm



TILLEY NASAL Dressing Forceps

BFD 94 - 132mm
BFD 95 - 160mm



SPONGE HOLDING Dressing Forceps

BFD 86 - 160mm
BFD 84 - 180mm
BFD 85 - 200mm
BFD 87 - 250mm

RAMPLEY
Dressing Forceps
BFD 92 - 250mm



Dressing Forceps

DOYENS
Dressing Forceps
185mm
BFD 332

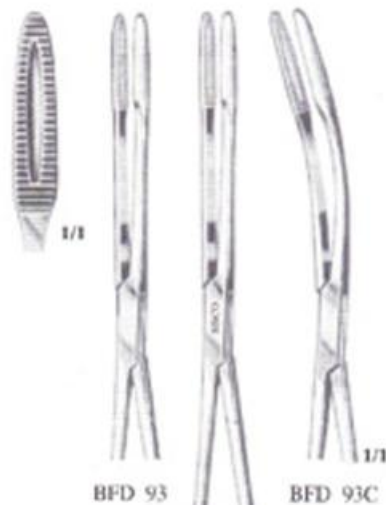

GROSS
Dressing Forceps
200mm
BFD 93 - Straight
BFD 93C - Curved



FOERSTER
Dressing Forceps
320mm
BFD 90



Grasping Forceps

ALLIS TISSUE Grasping Forceps

BGF 146 - 150mm
BGF 147 - 180mm
BGF 148 - 200mm



ALLIS TISSUE TRAUMANIL Grasping Forceps

BGF 155 - 150mm
BGF 156 - 180mm
BGF 157 - 200mm

BABCOCK Grasping Forceps

BGF 150 - 150mm
BGF 151 - 180mm
BGF 152 - 200mm



BABCOCK TISSUE TRAUMANIL Grasping Forceps

BGF 160 - 150mm
BGF 161 - 180mm
BGF 162 - 200mm



Towel Clamps

SCHADEL
Towel Clip
90mm

BTC 170



BTC 170



BTC 172



BTC 174 - 177



BTC 176

BTC 177

DOYENS
Towel Clip
130mm

BTC 172

BACKHAUS
Towel Clips

BTC 174 - 85mm

BTC 175 - 110mm

BTC 176 - 125mm

BTC 177 - 150mm

ROEDER
Towel Clip
135mm

BTC 185

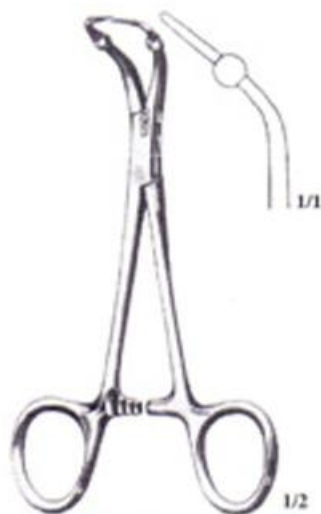

BTC 185

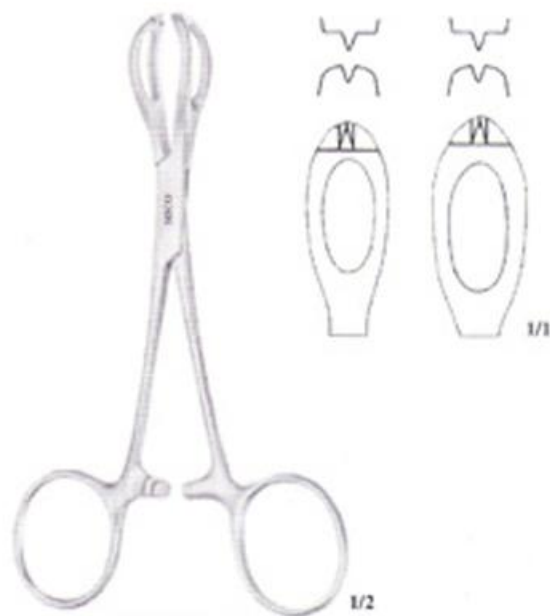

BTC 188 - 190

LANES
Towel Clips

BTC 188 - 150mm

BTC 189 - 180mm

BTC 190 - 200mm

MAYO SAFETY PIN
Instrument Holder
140mm

BTC 184

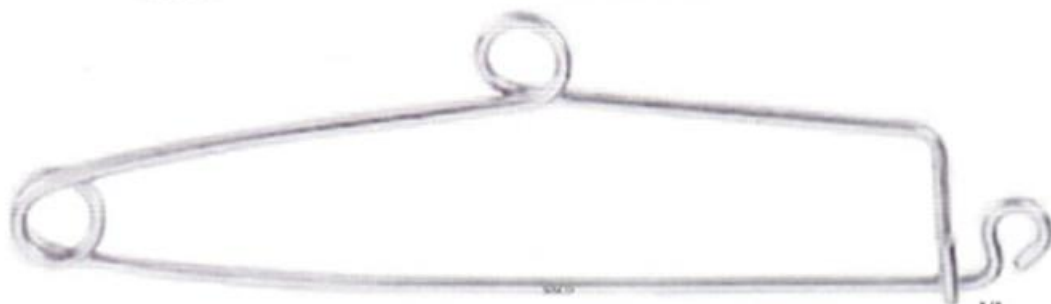

BTC 184

1/1



Dissecting Forceps

STANDARD Dissecting Forceps

Plain

- BDF 200 - 125mm
- BDF 201 - 150mm
- BDF 202 - 180mm
- BDF 203 - 200mm
- BDF 204 - 230mm
- BDF 205 - 250mm

STANDARD Dissecting Forceps

Toothed

- BDF 200T - 125mm
- BDF 201T - 150mm
- BDF 202T - 180mm
- BDF 203T - 200mm
- BDF 204T - 230mm
- BDF 205T - 250mm

FINE Dissecting Forceps

Plain

- BDF 210 - 125mm
- BDF 211 - 150mm
- BDF 212 - 180mm
- BDF 213 - 200mm
- BDF 214 - 230mm
- BDF 215 - 250mm

STANDARD Dissecting Forceps

Toothed

- BDF 210T - 125mm
- BDF 211T - 150mm
- BDF 212T - 180mm
- BDF 213T - 200mm
- BDF 214T - 230mm
- BDF 215T - 250mm

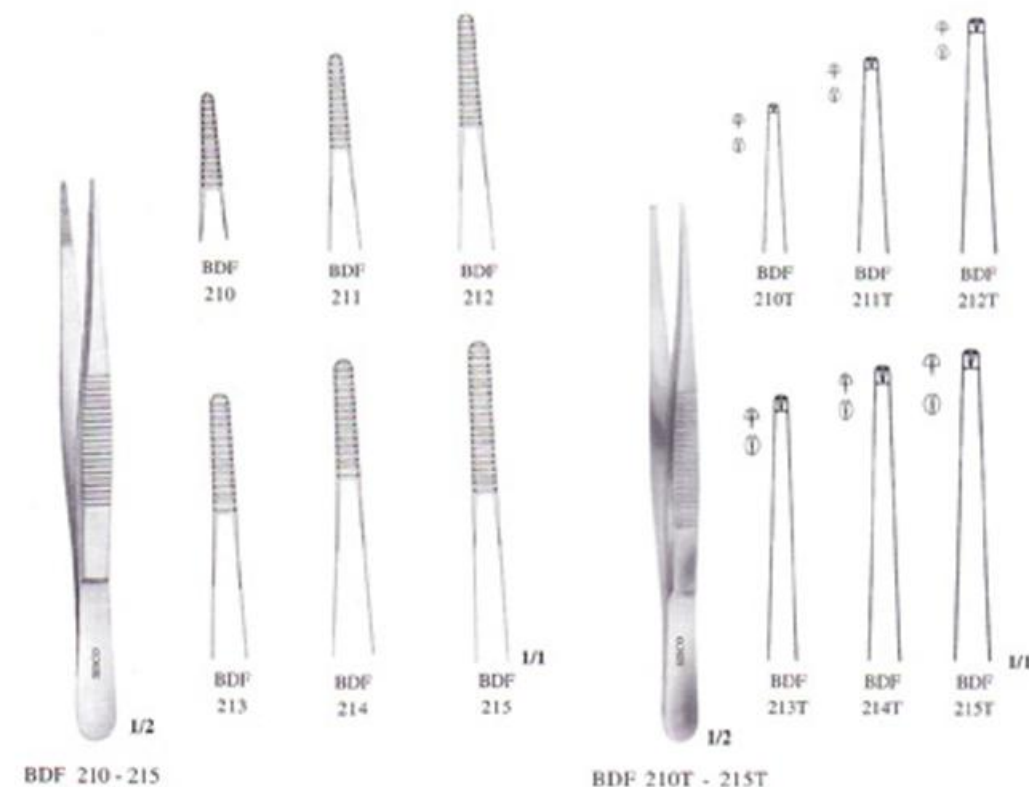
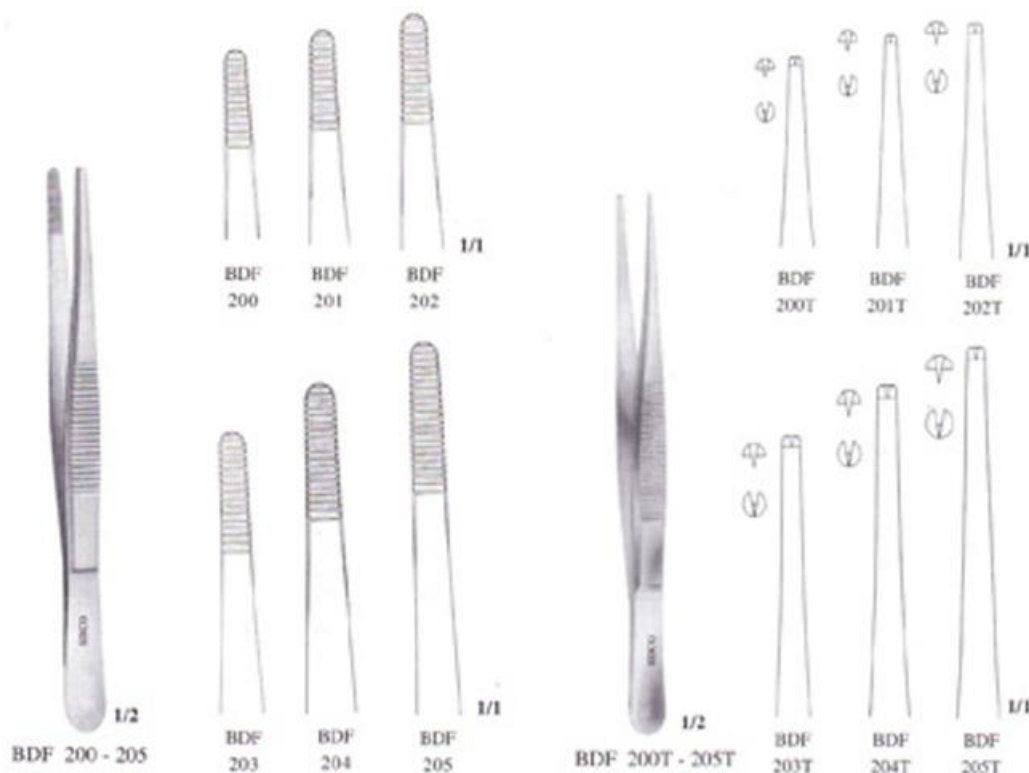



Dissecting Forceps

GILLIES Dissecting Forceps

Plain

- BDF 220 - 125mm
- BDF 221 - 150mm
- BDF 222 - 180mm
- BDF 223 - 200mm
- BDF 224 - 230mm
- BDF 225 - 250mm

GILLIES Dissecting Forceps

Toothed

- BDF 220T - 125mm
- BDF 221T - 150mm
- BDF 222T - 180mm
- BDF 223T - 200mm
- BDF 224T - 230mm
- BDF 225T - 250mm

BONNEYS Dissecting Forceps 180mm

- BDF 247 - Plain
- BDF 247T - Toothed

WAUGH Dissecting Forceps 200mm

- BDF 228 - Plain
- BDF 228T - Toothed

ALDER CREUTZ Dissecting Forceps 4 x 5 Teeth 200mm

- BDF 230



BDF 220 - 225



BDF 220T - 225T



BDF 247T



BDF 228



BDF 228T



BDF 230



ADSON
Dissecting Forceps

Plain

- BDF 235 - 125mm
- BDF 236 - 150mm
- BDF 237 - 180mm
- BDF 238 - 200mm

ADSON
Dissecting Forceps

Toothed

- BDF 235T - 125mm
- BDF 236T - 150mm
- BDF 237T - 180mm
- BDF 238T - 200mm

MICRO - ADSON
Dissecting Forceps, Fine

Plain

- BDF 240 - 150mm
- BDF 241 - 180mm
- BDF 242 - 200mm

MICRO - ADSON
Dissecting Forceps, Fine

Toothed

- BDF 240T - 150mm
- BDF 241T - 180mm
- BDF 242T - 200mm

McINDOE
Dissecting Forceps

- 150mm
- BDF 245

CHARNLEY McINDOE
Dissecting Forceps

- 150mm
- BDF 250

EVANS McINDOE
Dissecting Forceps

- 150mm
- BDF 252



1/2
BDF 235 - 238



1/1
1/2
BDF 235T - 238T



1/2
BDF 240 - 242



1/2
BDF 240T - 242T



1/2
BDF 245



1/2
BDF 250



1/2
BDF 252





Dissecting Forceps

RUSSIAN Dissecting Forceps

BDF 253 - 160mm
BDF 254 - 180mm
BDF 267 - 200mm

CUSHING BAYONET Dissecting Forceps *Plain*

BDF 257 - 180mm
BDF 258 - 200mm

CUSHING BAYONET Dissecting Forceps *Toothed*

BDF 257T - 180mm
BDF 258T - 200mm

HUNT Dissecting Forceps 200mm *Serrated*

BDF 260

HUNT Dissecting Forceps 200mm *Plain*

BDF 260P

TUTTLE Dissecting Forceps

BDF 262 - 200mm
BDF 263 - 230mm

NELSON Dissecting Forceps

BDF 265 - 200mm
BDF 266 - 230mm



BDF 254



BDF 257 - 258



BDF 257T - 258T



BDF 260



BDF 260P



BDF 262 - 263



BDF 265 - 266

IRIS
Scissors
115mm

BSC 338 - Straight
BSC 338C - Curved



CUTICLE
Scissors
100mm

BSC 322 - Straight
BSC 322C - Curved

DOYENS
Scissors, Heavy
180mm
BSC 310

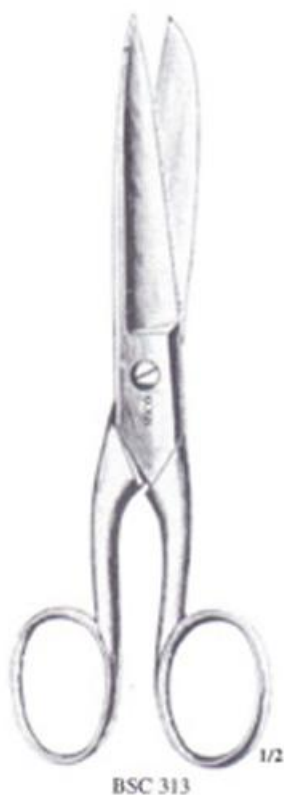

SHOP
Scissors
180mm
BSC 312

SHOP
Scissors, Heavy
200mm
BSC 313

DRESSING SCISSORS

Blunt X Blunt

Straight

BSC 307 - 125mm

BSC 308 - 150mm

BSC 309 - 180mm

Curved

BSC 307C - 125mm

BSC 308C - 150mm

BSC 309C - 180mm



DRESSING SCISSORS

Sharp X Sharp

Straight

BSC 301 - 125mm

BSC 302 - 150mm

BSC 303 - 180mm

Curved

BSC 301C - 125mm

BSC 302C - 150mm

BSC 303C - 180mm





DRESSING SCISSORS

Sharp X Blunt

Straight

BSC 304 - 125mm

BSC 305 - 150mm

BSC 306 - 180mm

Curved

BSC 304C - 125mm

BSC 305C - 150mm

BSC 306C - 180mm



BSC 304



BSC 305



BSC 306



BSC 304C



BSC 305C



BSC 306C

1/1

SPENCER

Ligature Scissor

90mm

BSC 317



1/1



1/1

LITTAUER

Ligature Scissor

BSC 318 - 115mm

BSC 319 - 135mm



BSC 318 - 319

1/1



Scissors

LISTER Bandage Cutting Scissors

BSC 315 - 180mm
BSC 315A - 200mm



BEEBE Wire Cutting Scissor One Blade Serrated 125mm

BSC 325

WIRE CUTTER Angled, 1 Blade Serrated 120mm

BSC 326



HEATHS Suture Removal Scissor One Blade Serrated 180mm

BSC 327 - 150mm

BSC 328 - 180mm

1/1

BSC 326

41

BSC 327 - 328

3/4

MAYOS Scissors

Straight

BSC 330 - 135mm

BSC 331 - 160mm

BSC 332 - 185mm

Curved

BSC 330C - 135mm

BSC 331C - 160mm

BSC 332C - 185mm

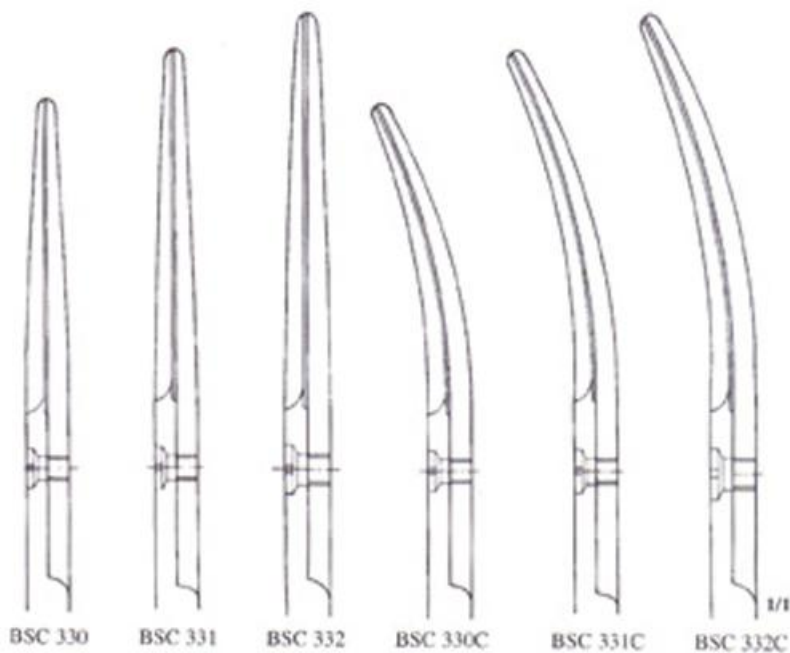

MAYOS Scissors

Straight

BSC 333 - 205mm

BSC 334 - 230mm

BSC 335 - 250mm

Curved

BSC 333C - 205mm

BSC 334C - 230mm

BSC 335C - 250mm

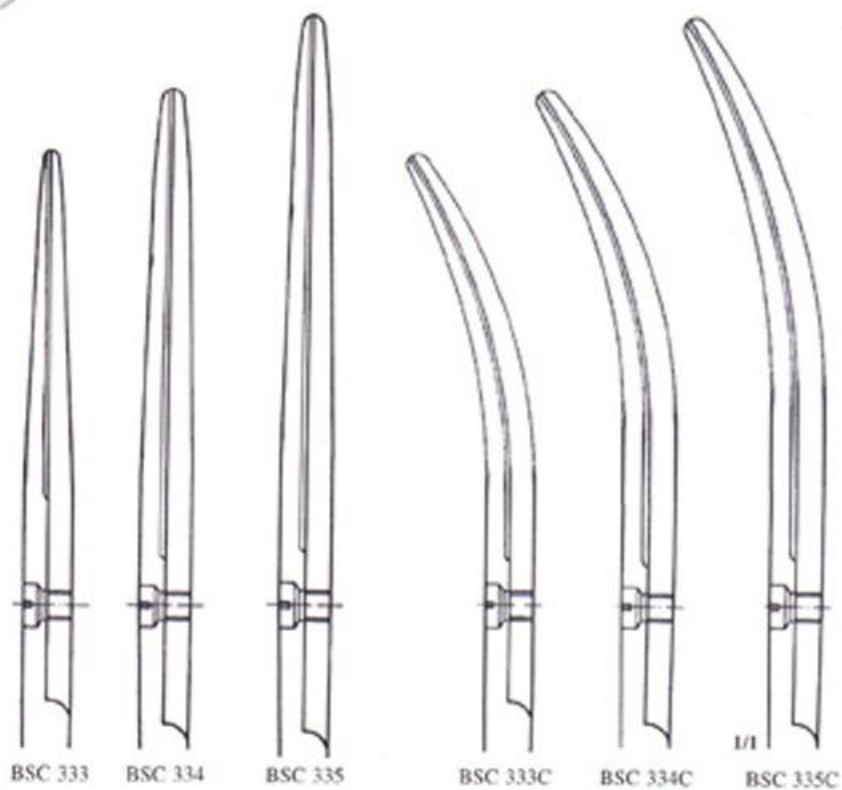
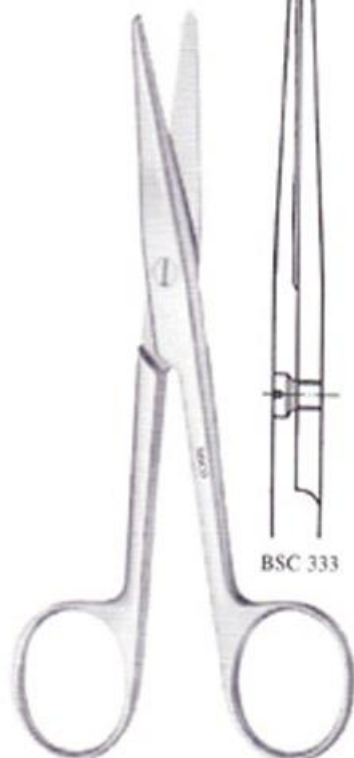

METZENBAUM

Scissors

Straight

BSC 340 - 150mm

BSC 341 - 180mm

BSC 342 - 200mm

BSC 343 - 230mm

BSC 344 - 250mm

BSC 345 - 280mm



1/1

BSC
340

BSC
341

BSC
342

BSC
343

BSC
344

BSC
345



1/1

METZENBAUM

Scissors

Curved

BSC 340C - 150mm

BSC 341C - 180mm

BSC 342C - 200mm

BSC 343C - 230mm

BSC 344C - 250mm

BSC 345C - 280mm



1/1

BSC
340C

BSC
341C

BSC
342C

BSC
343C

BSC
344C

BSC
345C



KILNER
Scissors
120mm
BSC 339

POTTS
Angled Scissors
190mm

BSC 352 - 25 Deg.
BSC 353 - 45 Deg.
BSC 354 - 60 Deg.

YASARGIL
Flat Type Scissors

Straight

BSC 360 - 160mm
BSC 361 - 185mm

Curved

BSC 360C - 160mm
BSC 361C - 185mm

Angled

BSC 390 - 160mm

YASARGIL
Round Type Scissors

Straight

BSC 365 - 160mm
BSC 366 - 185mm

Curved

BSC 365C - 160mm
BSC 366C - 185mm

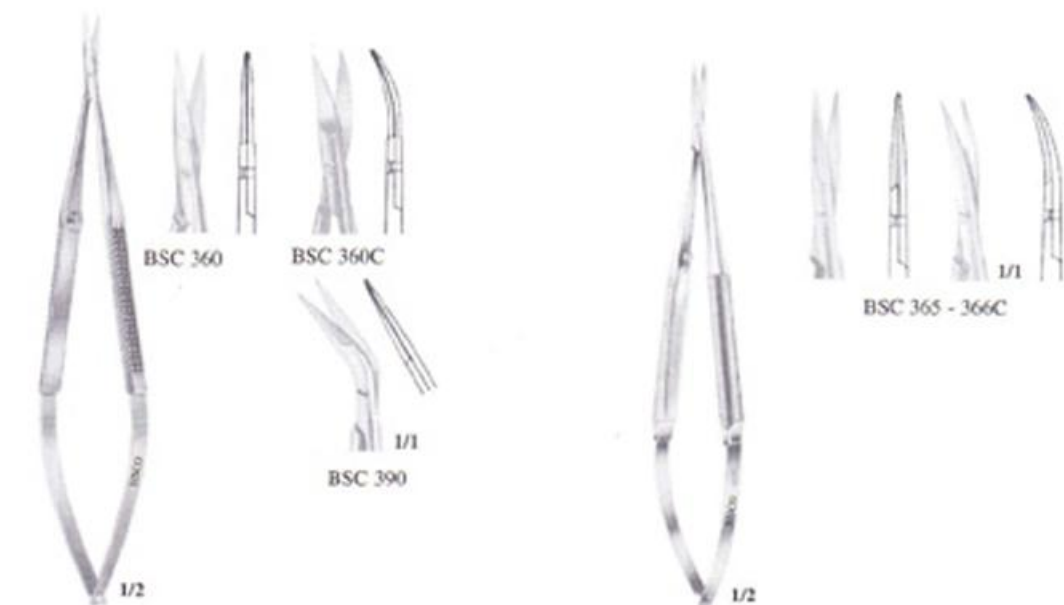



Needle Holders

MAYO HEGARS Needle Holders

- BNH 405 - 125mm
- BNH 406 - 150mm
- BNH 407 - 180mm
- BNH 408 - 200mm
- BNH 409 - 230mm



HEGARS Needle Holders, Heavy

- BNH 416 - 150mm
- BNH 417 - 180mm
- BNH 418 - 200mm
- BNH 419 - 230mm

DEBAKEY Needle Holders

- BNH 457 - 180mm
- BNH 458 - 200mm
- BNH 459 - 230mm

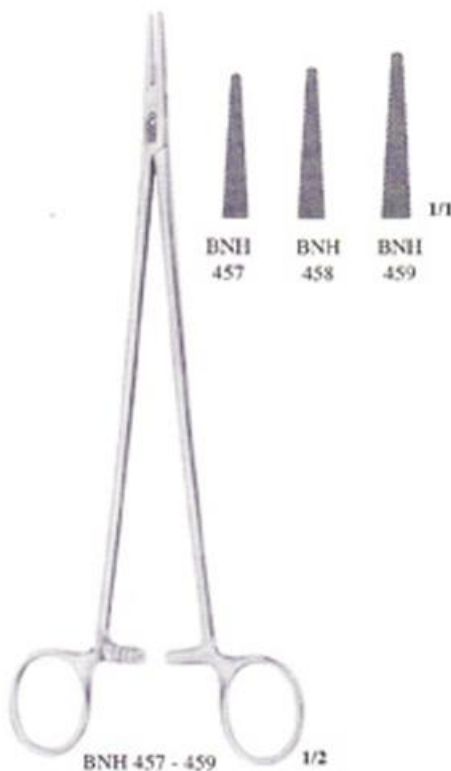

CRILE - WOOD Needle Holders

- BNH 422 - 150mm
- BNH 423 - 175mm
- BNH 424 - 200mm



BOZEMANN Needle Holders Bayonet

BNH 446 - 150mm
BNH 447 - 180mm
BNH 448 - 200mm



KILNER Needle Holders Bayonet 140mm BNH 442

RYDER Needle Holders Delicate, 1mm

BNH 435 - 125mm
BNH 436 - 150mm
BNH 437 - 180mm
BNH 438 - 200mm



RYDER Needle Holders 1.5mm

BNH 425 - 125mm
BNH 426 - 150mm
BNH 427 - 180mm
BNH 428 - 200mm



Needle Holders

LAWRENCE
Needle Holders
150mm

BNH 454



CONVERSE WEBSTER
Needle Holders
125mm

BNH 430

DERF
Needle Holders
125mm

BNH 812

WEBSTER
Needle Holders, Plain
125mm

BNH 014



HALSEY
Needle Holders
130mm

BNH 012P - Plain
BNH 012 - Serrated



Needle Holders

HEANEY
Needle Holders
200mm
BNH 259



FINOCHIETTO
Needle Holders
260mm
BNH 412 - Straight
BNH 412A - Angled



MATHIEU UNIVERSAL
Needle Holders
BNH 450 - 170mm
BNH 451 - 200mm

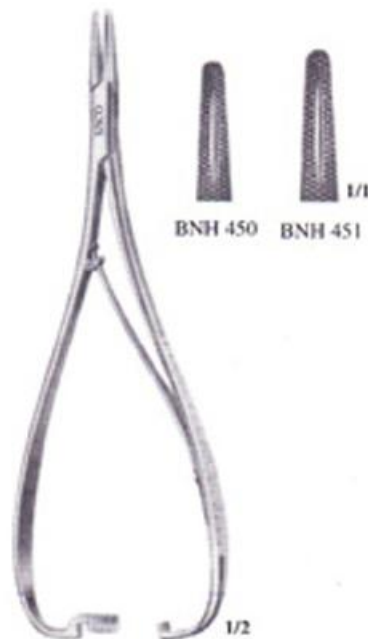

GILLIES
Scissors with
Needle Holders
160mm
BNH 465

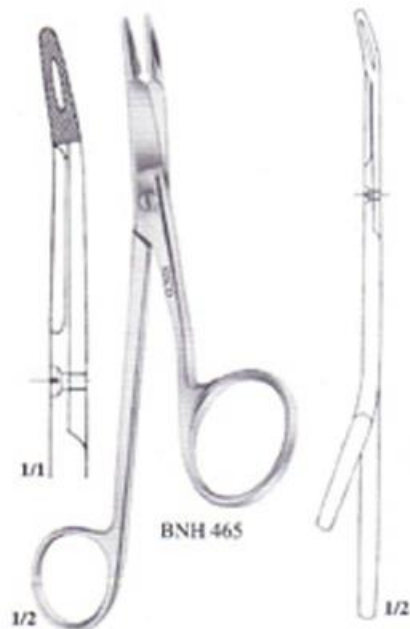



Needle Holders

CASTROVIEJO Needle Holders With Catch, Flat Handles

Straight

BNH 470 - 140mm
BNH 471 - 160mm
BNH 472 - 185mm

Curved

BNH 470C - 140mm
BNH 471C - 160mm
BNH 472C - 185mm

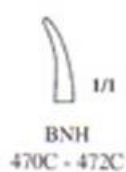

CASTROVIEJO Needle Holders Without Catch, Flat Handles

Straight

BNH 478 - 140mm
BNH 479 - 160mm
BNH 383 - 185mm

Curved

BNH 478C - 140mm
BNH 479C - 160mm
BNH 383C - 185mm

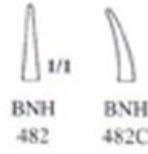
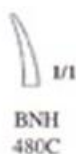

CASTROVIEJO Needle Holders Without Catch, Round Handles 180mm

BNH 480 - Straight
BNH 480C - Curved

CASTROVIEJO Needle Holders With Catch, Round Handles 180mm

BNH 482 - Straight
BNH 482C - Curved



DIRECTOR WITH ANEURYSM NEEDLE
110mm

BDR 912

PROBE POINTED WITH TOUNGE TIE
170mm

BDR 914

DIRECTOR WITH TOUNGE TIE
140mm

BDR 918

PROBE DOUBLE ENDED MALLEABLE

BPR 827 - 180mm

BPR 828 - 200mm

BPR 825 - 250mm

BPR 826 - 300mm

MALLEABLE PROBE WITH EYE

BPR 822 - 125mm

BPR 823 - 150mm

BPR 824 - 200mm

THYROID DISSECTOR

BDR 901 - 170mm

DIRECTOR AND RASPATORY DURHAM

200mm

BDR 915

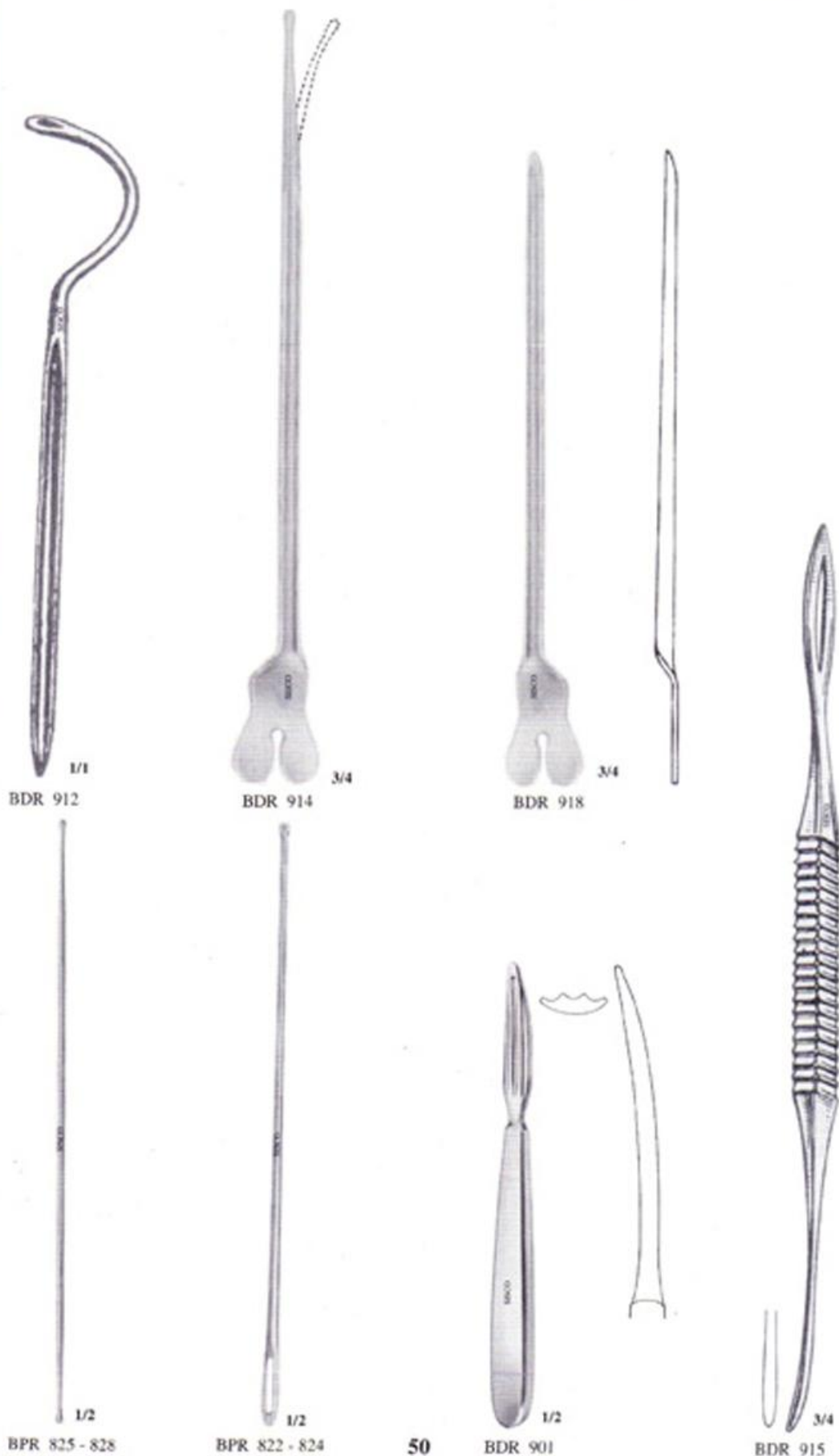



LOCKHARTMUMMERY

Fistula Probes

165mm

BDS 921 - Straight

BDS 922 - 45° Curved

BDS 923 - 90° Curved

BDS 924 - Retrograde Curved

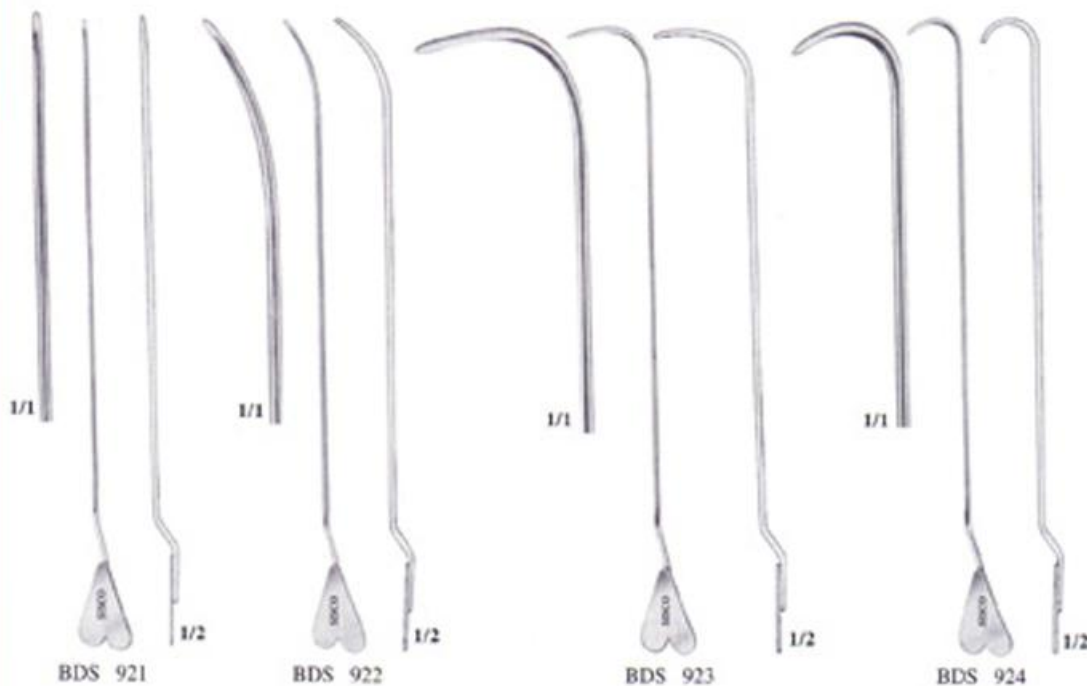

WATSON CHEYNE

Dissector

180mm

BDS 927

McDONALD

Dissector

185mm

BDS 928

PENNEY BECKER

Dissector

230mm

BDS 349

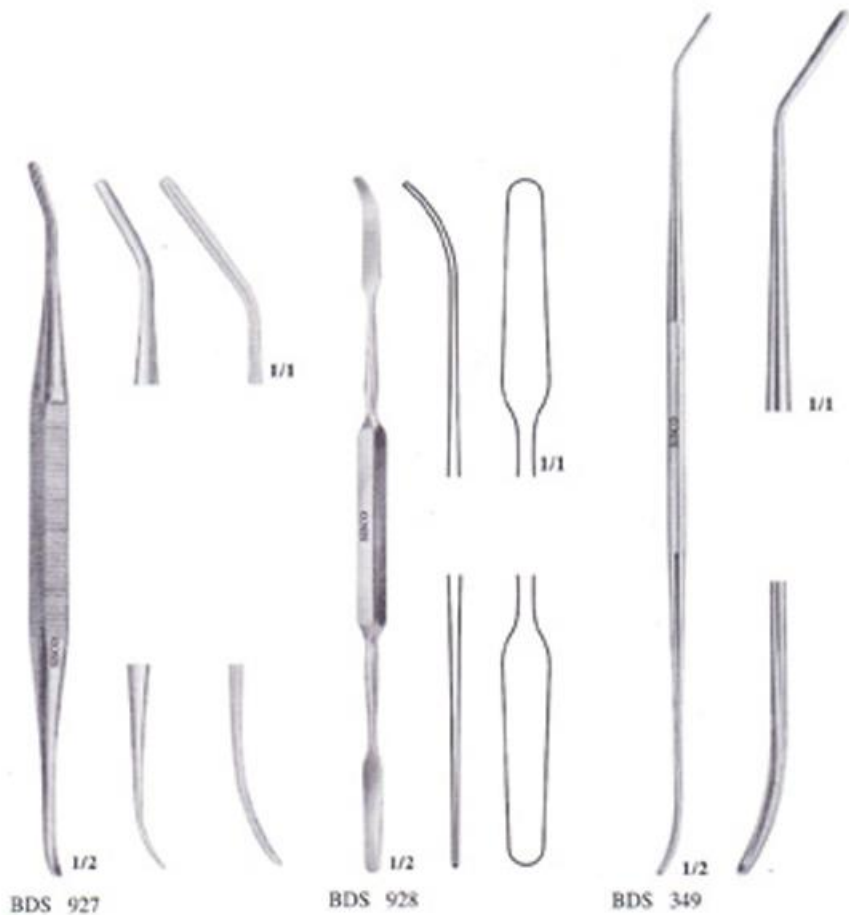



**BILEDUCT
Dilators (Set of 9)
300mm
BDL 980S**

**TRACHEAL
Dilators
120mm
BDL 945**

**CLUTTON
Dilators (Set of 12)
270mm
BDL 970**

**LISTERS
Dilators (Set of 12)
280mm
BDL 950S**

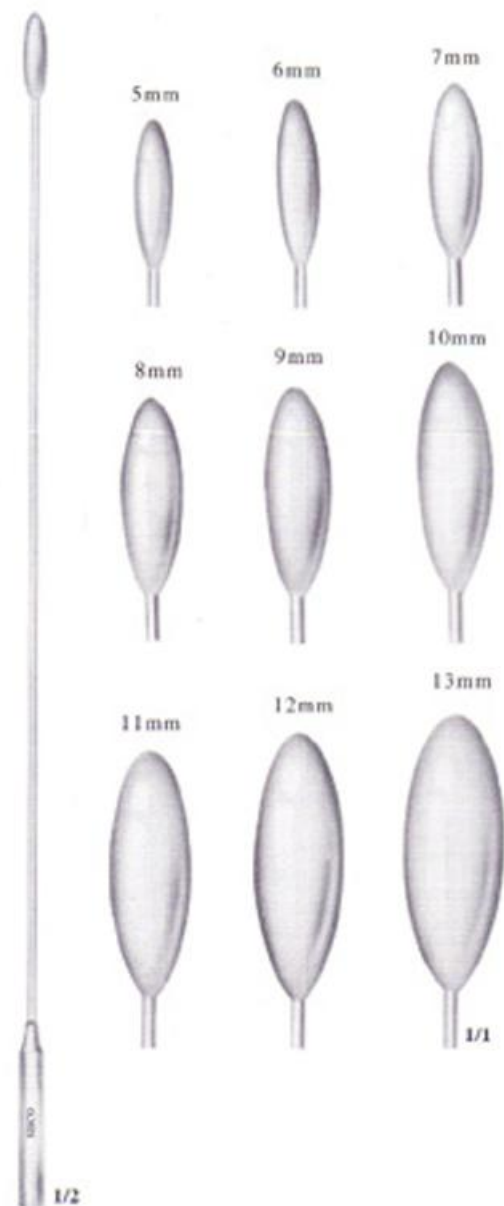

BDL 980S



BDL 945

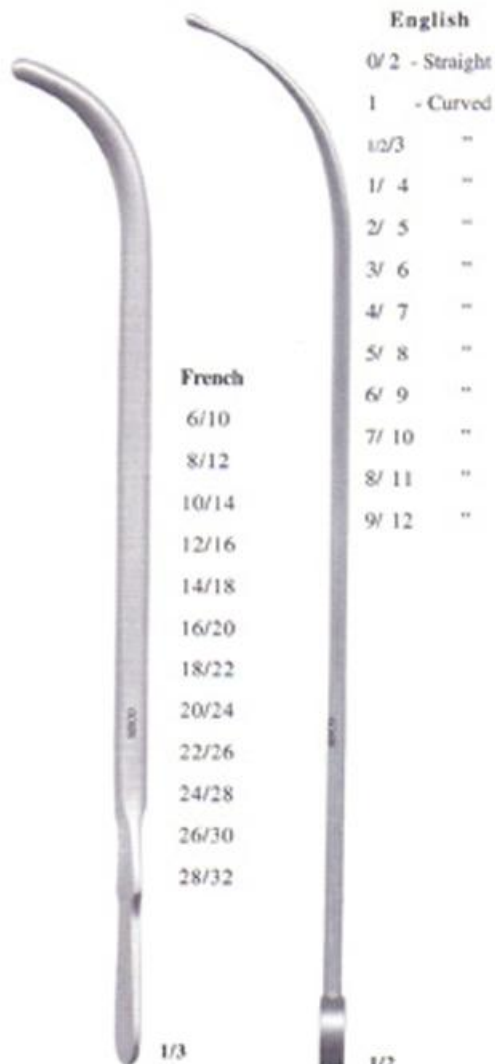

BDL 970

BDL 950S

English	
0/2	- Straight
1	- Curved
1/2/3	"
1/4	"
2/5	"
3/6	"
4/7	"
5/8	"
6/9	"
7/10	"
8/11	"
9/12	"

French	
6/10	
8/12	
10/14	
12/16	
14/18	
16/20	
18/22	
20/24	
22/26	
24/28	
26/30	
28/32	



Resection Clamp

HAYES LOW
Resection Clamp
Autrametic jaw
Jaw 95mm
Length 225mm

BFR 555



BFR 555

HAYES LOW
Resection Clamp
Autrametic jaw
Jaw 102mm
Length 250mm

BFR 556



BFR 556



Clip Applying & Removing Forceps

MICHEL
Clip Applying Forceps
125mm

BAP 830



BAP 830 1/2



BAP 835 1/2

MICHEL
Clip Applying And
Removing Forceps
125mm

BAP 835

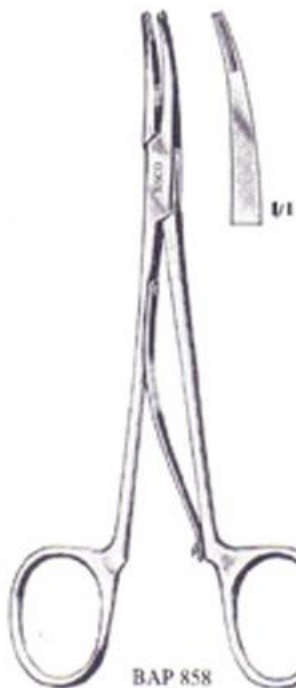

BAP 858 1/2

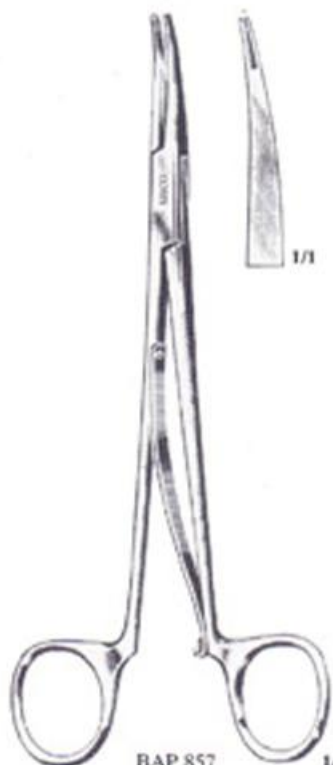

BAP 857 1/2

SILVER
Clip Applying Forceps
180mm

BAP 858

SILVER
Clip Applying Forceps
200mm

BAP 857

SILVER
Clip Magazine

BAP 859

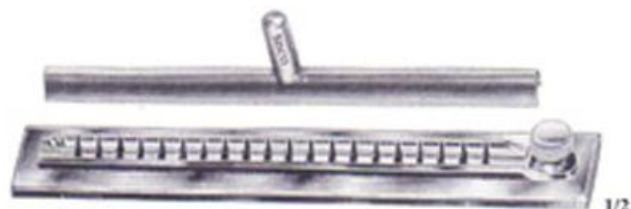

BAP 859 1/2



Ligature Instruments

DESCHAMPS
Ligature, Sharp
210mm

BLI 870S - Right
BLI 871S - Left



BLI 870S

BLI 871S



BLI 870

BLI 871

DESCHAMPS
Ligature, Blunt
210mm

BLI 870 - Right
BLI 871 - Left

REVERDIN
Ligature
195mm

BLI 880 - BLI 883

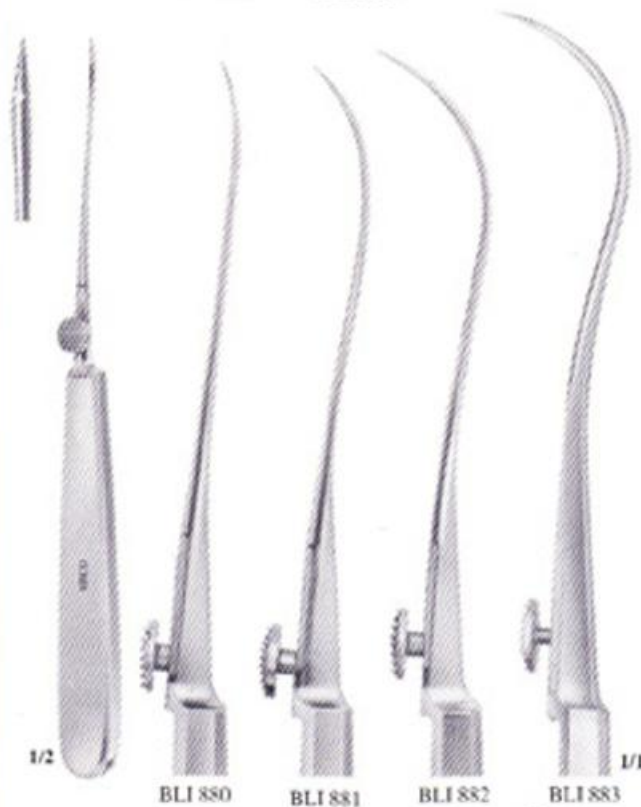

BLI 880

BLI 881

BLI 882

BLI 883

MILLIN
Ligature Holding Forceps
245mm

BLI 885



BLI 885



NELSON
Hydrocele Trocar
170mm
BTR 510



UNIVERSAL
Trocars (Set of 4)
BTR 126

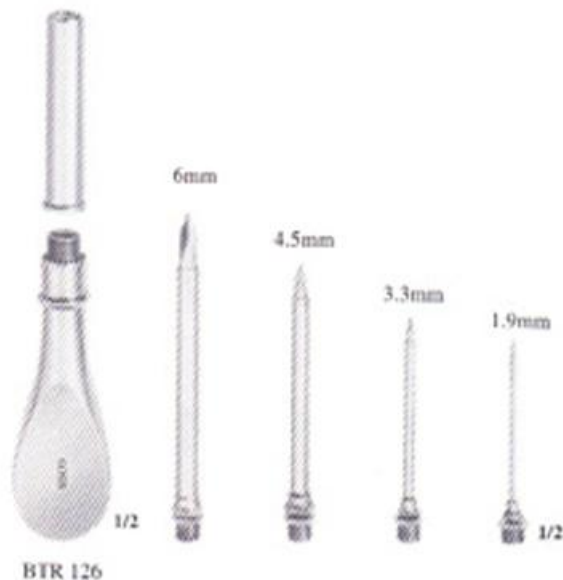

SUPRAPUBIC
Trocars & Cannula
210mm
BTR 520 - 6mm
BTR 520S - 8mm
BTR 520M - 10mm
BTR 520L - 12mm

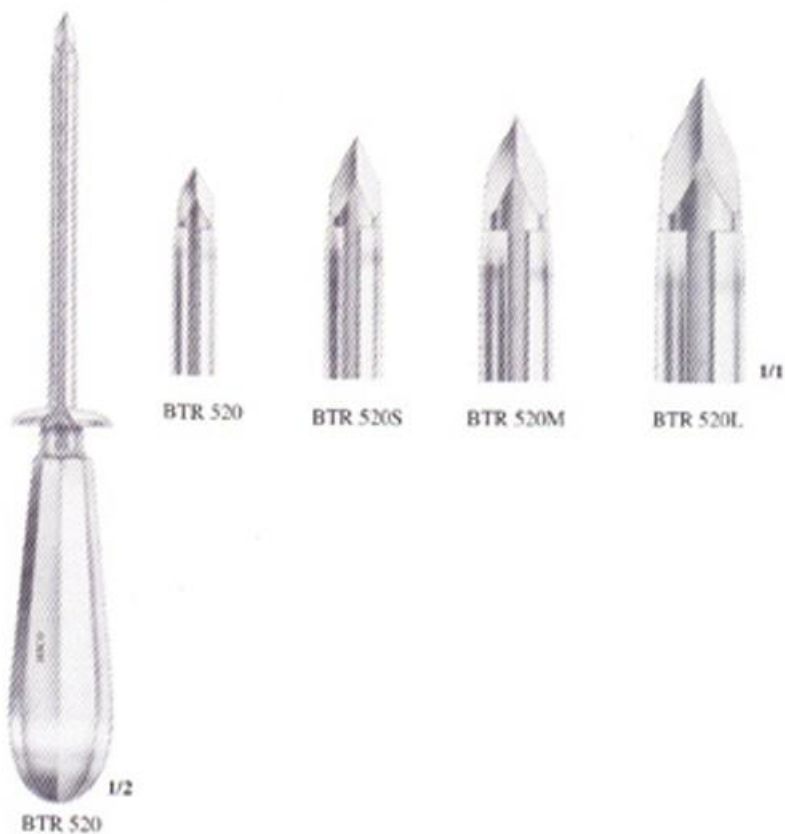



YAUNKERS Suction Tube

GIYST (BST 530)



GIYST
(BST 530)

POOLS Suction Tube

GIPSTS (BST 532) -STR.
GIPSTC (BST532C) -CVD.



GIPSTS
(BST 532)

GIPSTC
(BST 532C)

FERGUSSON Suction Tip With Stillet

GIFST 01 - Size 1
GIFST 02 - Size 2
GIFST 03 - Size 3
GIFST 04 - Size 4
GIFST 05 - Size 5

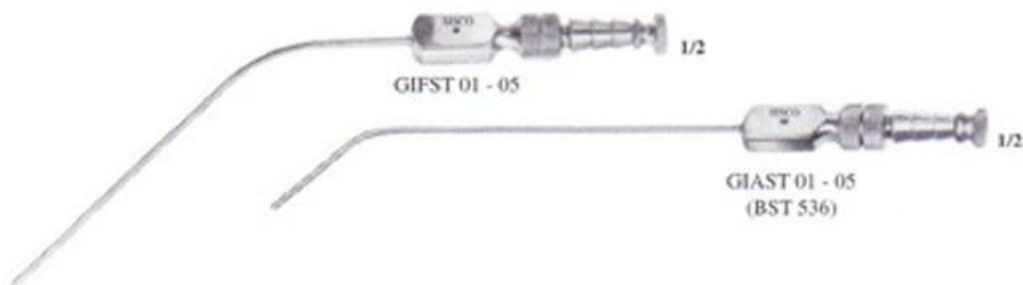

GIFST 01 - 05

GIAST 01 - 05
(BST 536)

AMERICAN PATTERN Suction Tip With Stillet BST 536

GIAST 01 - Size 1
GIAST 02 - Size 2
GIAST 03 - Size 3
GIAST 04 - Size 4
GIAST 05 - Size 5



Rectal Instruments

COLON
Rectal Clamp
230mm
BFR 550



1/1



BFR 552

1/2

PARKER KERR
Rectal Clamp
230mm
BFR 552



BFR 550



1/1

BFR 557

1/2

BOWEL OCCLUSION
Rectal Clamp
215mm
BFR 557

GRAEME
 Rectal Speculum With
 Oblique End
 BFR 561 -S - 52 x 12mm
 BFR 561 -M - 65 x 19mm
 BFR 561 -L - 75 x 20mm

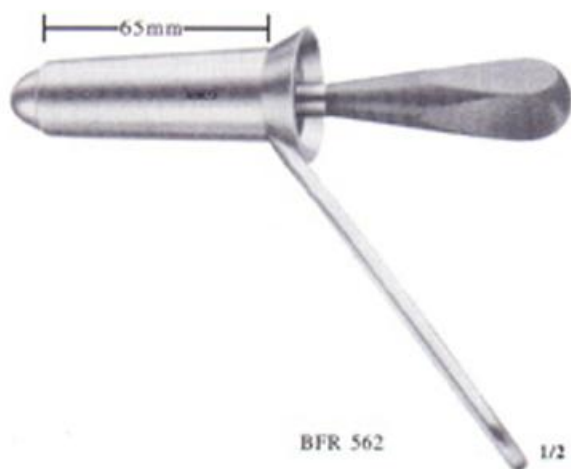
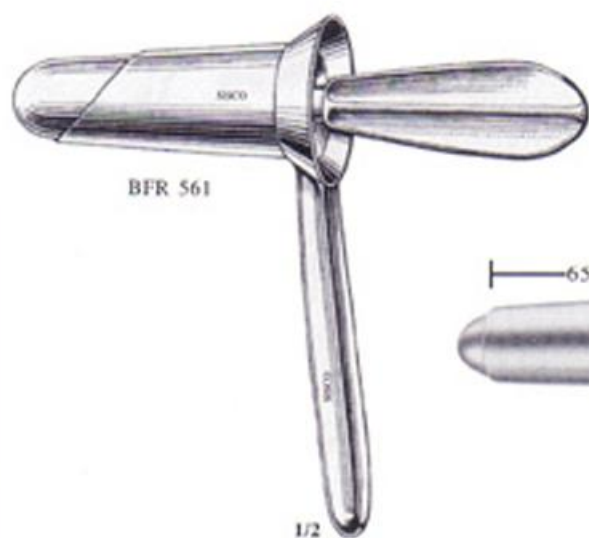

GABRIEL
 Rectal Speculum
 BFR 562 - 64 x 25mm

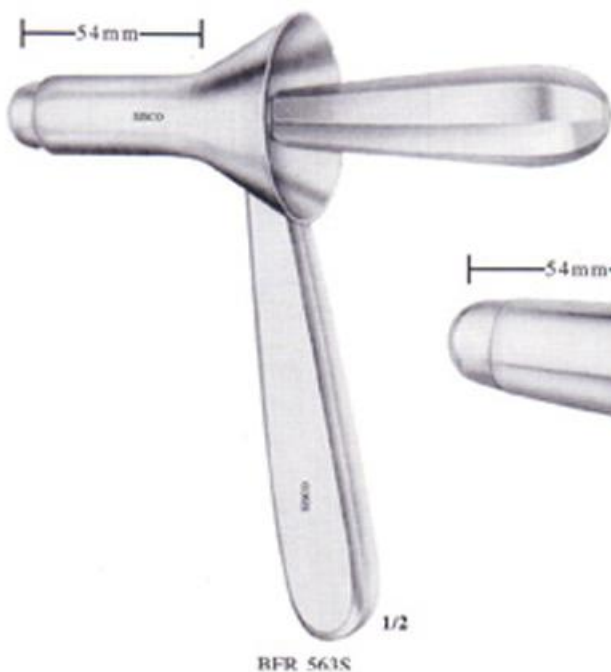

KELLYS
 Rectal Speculum
 BFR 563 - S - 21 x 54mm
 BFR 563 - M - 27 x 54mm



Rectal Grasping & Biopsy Forceps

CHEVALIER JACKSON Grasping Forceps

- BFR 566 - 300mm
- BFR 567 - 350mm
- BFR 568 - 400mm
- BFR 569 - 450mm
- BFR 570 - 500mm
- BFR 571 - 550mm

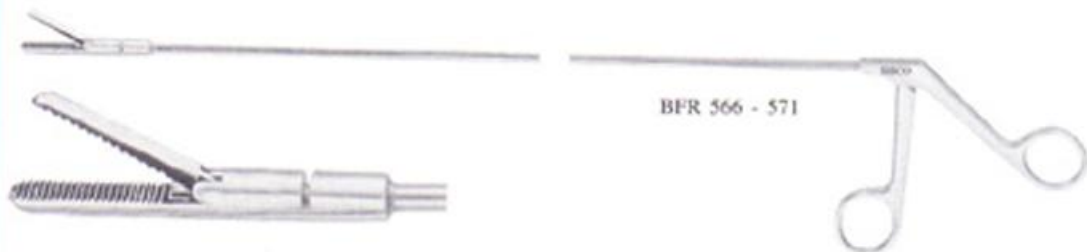

CHEVALIER JACKSON Biopsy Forceps

- BFR 572 - 350mm
- BFR 573 - 400mm
- BFR 574 - 450mm
- BFR 575 - 500mm
- BFR 576 - 550mm
- BFR 577 - 600mm



EXTRAFINE Crocodile Forceps Serrated Jaw

- BFR 578 - 350mm



YEOMEN Biopsy Forceps

- BFR 579 - 355mm
- BFR 580 - 255mm

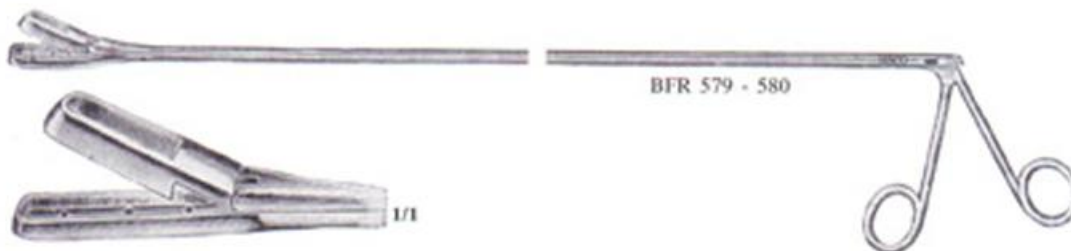

PATTERSONS Biopsy Forceps

- BFR 581 - 250mm
- BFR 582 - 300mm
- BFR 583 - 350mm
- BFR 584 - 400mm
- BFR 585 - 450mm
- BFR 586 - 500mm

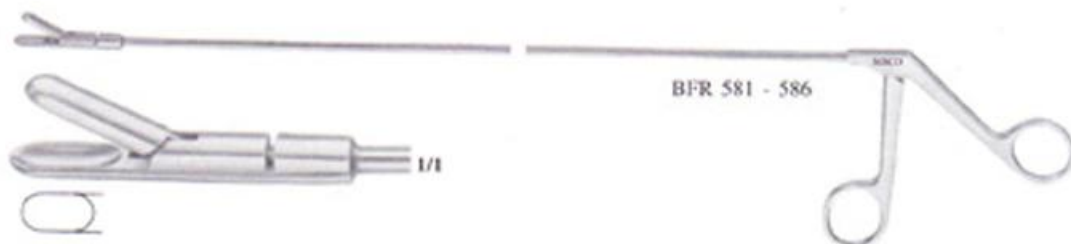



Rectal Instruments

22 X 92mm

17 X 65mm

PARKS ANAL Retractor

BFR 590 - Child
BFR 591 - Adult



PARKS ANAL Retractor 3 Pairs of Side Blades 1 Centre Blade BFR 592

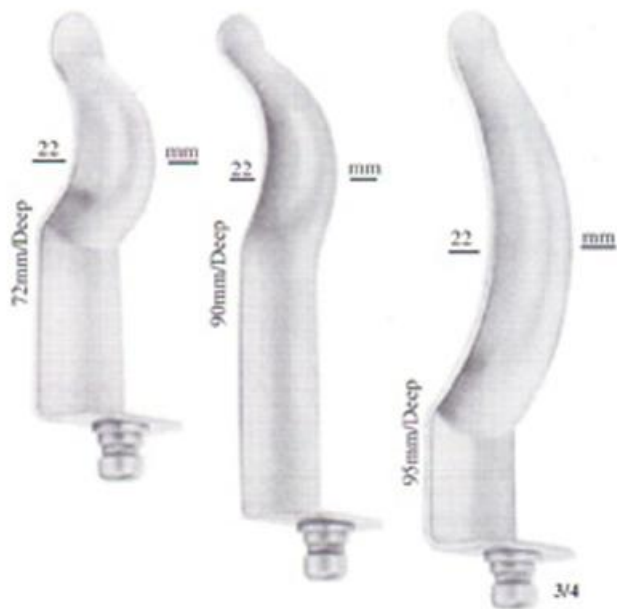

LLOYDDAVIS
Rectal Clamp
315mm

BFR 558



1/1



BFR 589

LORD
Rectal Dilator
BFR 589 - 35mm

ST. MARKS HOSPITAL
Rectal Dilator

BFR 587 - 20mm
BFR 588 - 25mm



BFR 558

1/2



BFR 587 - 588



Gall Bladder Forceps

HEISS
Gall Bladder Forceps
200mm

Toothed
BGB 15 - Straight
BGB 15C - Curved

Plain
BGB 16 - Straight
BGB 16C - Curved

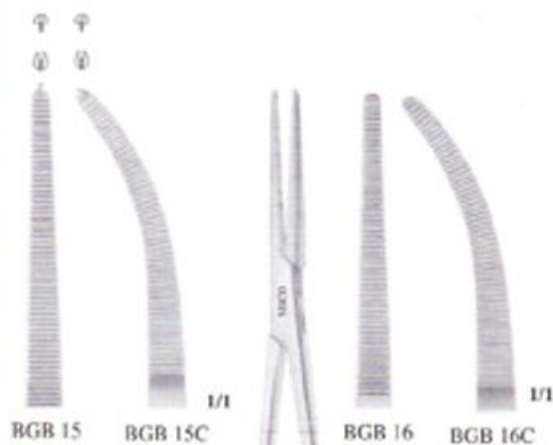

LLOYD DAVIS
Gall Bladder Forceps
250mm

BGB 18

ADRENALECTOMY
Gall Bladder Forceps
265mm

BGB 20

DUMFIELD ROSE
Gall Bladder Forceps
260mm

BGB 22

HERNIA RING
Forceps
145mm

BGB 25

BISTOURY HERNIA
180mm

BGB 27

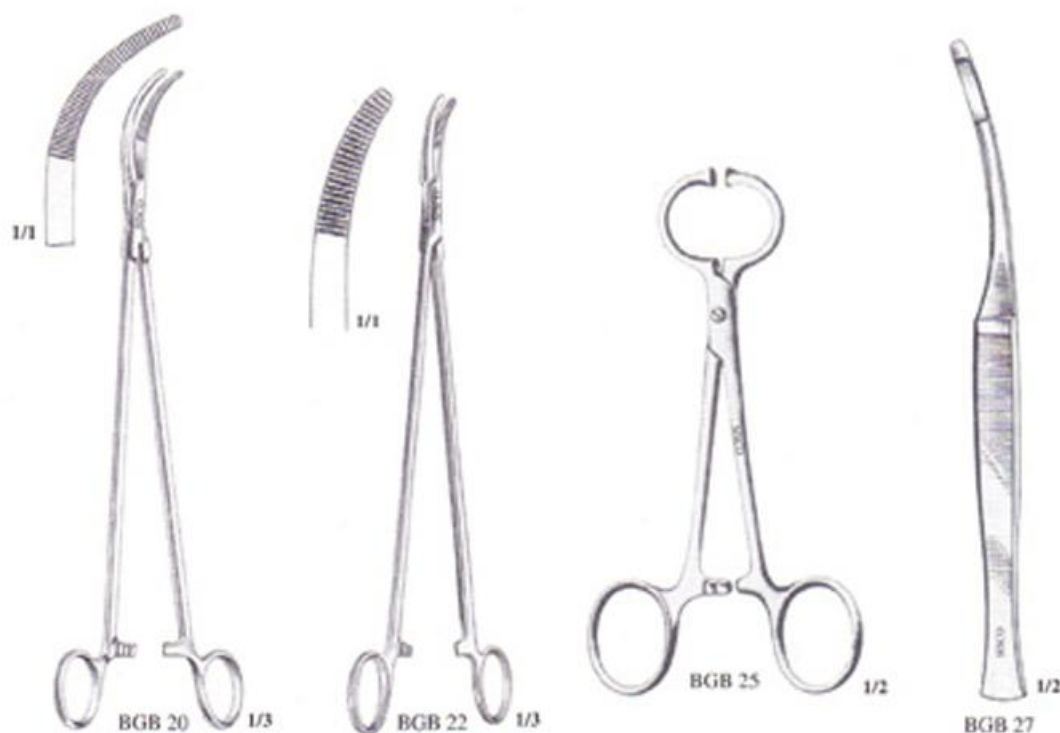



Gall Bladder Forceps

GRAY
Gall Bladder Forceps
220mm

BGB 30
BGB 31

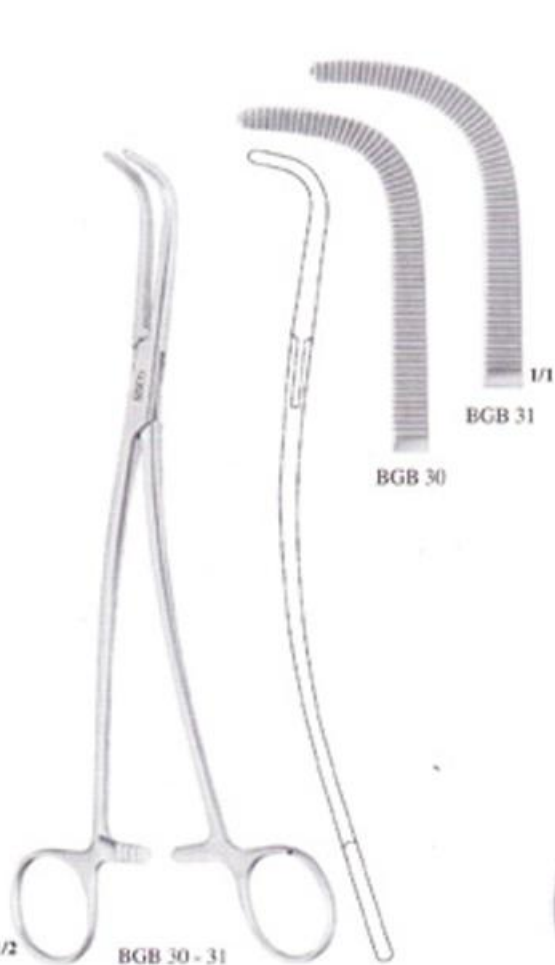

MOYNIHANS
Gall Bladder Forceps
230mm

BGB 34
BGB 35

TURNER WARWICK
Gall Bladder Forceps
195mm

BGB 40

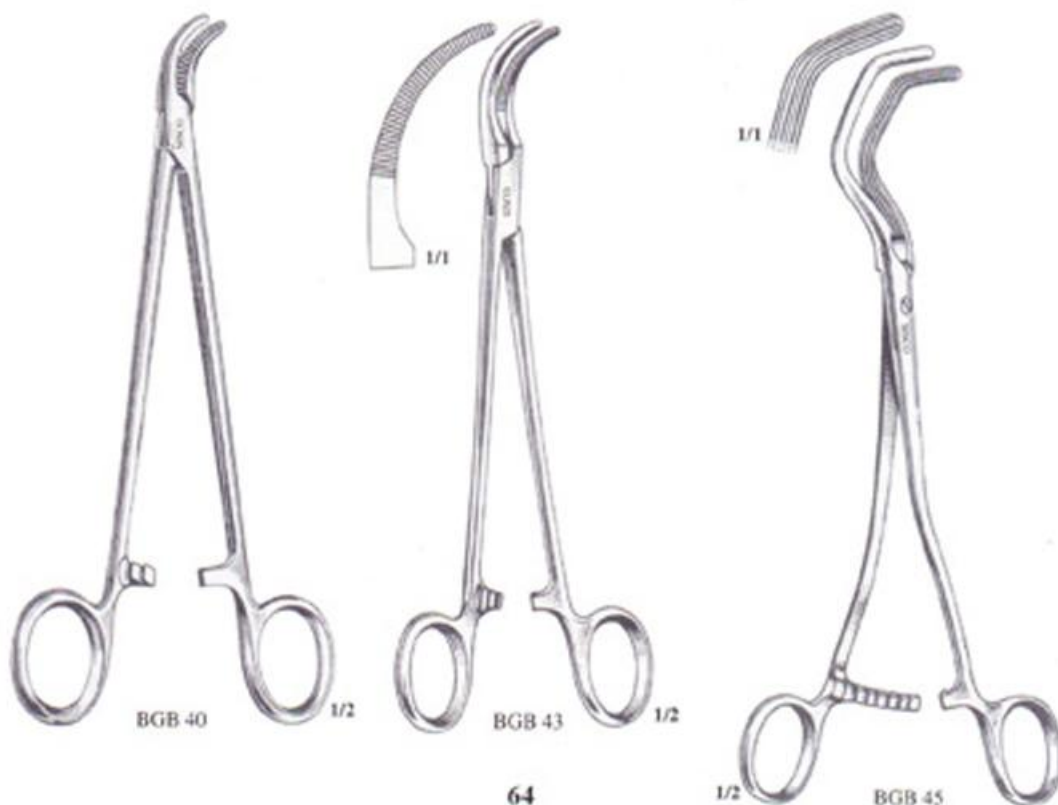

WILKIE
Gall Bladder Forceps
190mm

BGB 43

WELLS
Protocaval Anastomosis
Gall Bladder Forceps
220mm

BGB 45



Gall Bladder Forceps

RANDALLS
Common Duct
Gall Bladder Forceps
Set of 4, Serrated Tip
225mm
BGB 50 - 53



DESJARDINS
Gall Bladder Forceps
230mm
BGB 58 - 59

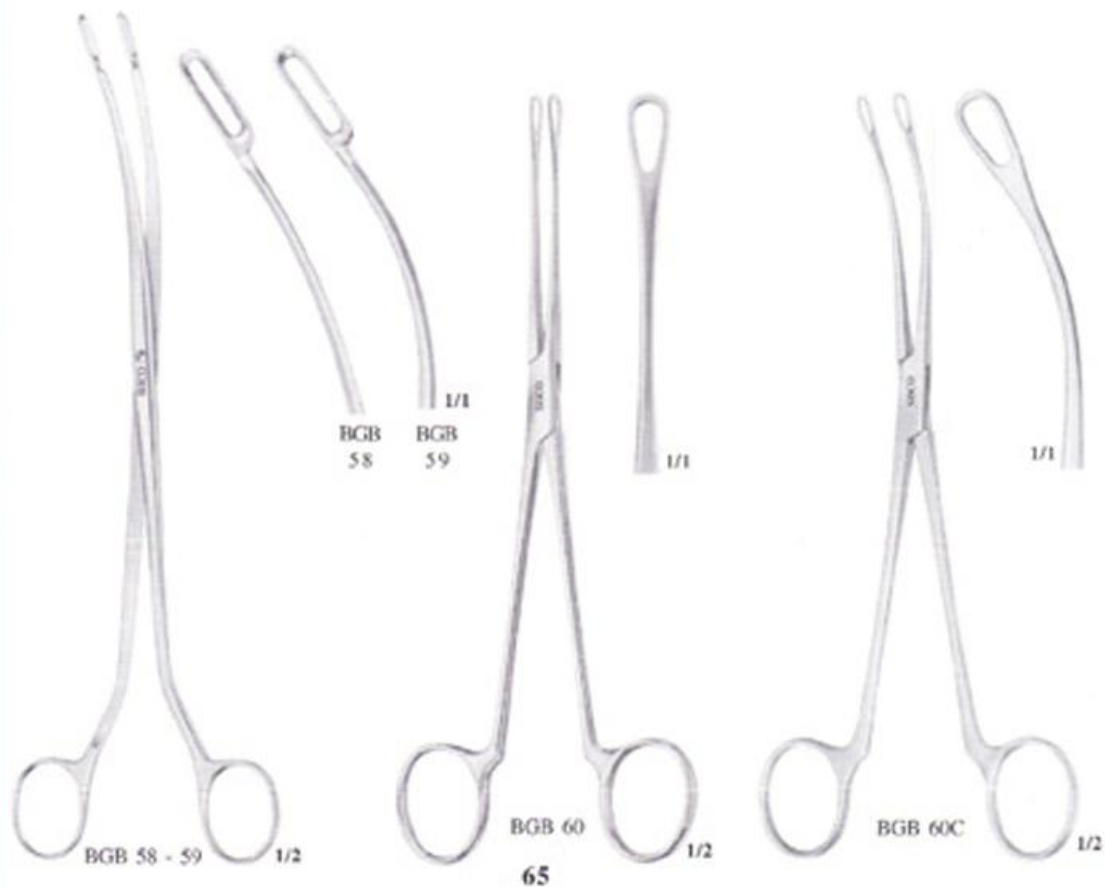

BLAKE
Gall Bladder Forceps
200mm
BGB 60 - Straight
BGB 60C - Curved



Gall Bladder Forceps & Probes

MOYNIHAN
Gall Stone Probe & Scoop
Malleable
365mm
BGB 150

WERTHEIM
Kidney Pedicle Clamp
255mm
BFU 574

HERRICK
Kidney Pedicle Clamp
225mm
BFU 545

DESJARDINS
Gall Duct Probes
Malleable
285mm
BGB 101 - 103



LANES
Gastro - Intestinal Forceps
300mm

BIF 65 - Straight
BIF 65C - Curved





PAYRS
Intestinal And Pyldrus
Clamps
70mm X 200mm
BIF 70 - Small

PAYRS
Intestinal And Pyldrus
Clamps
110mm X 275mm
BIF 68 - Medium

PAYRS
Intestinal And Pyldrus
Clamps
145mm X 315mm
BIF 69 - Large





Intestinal And Grasping Forceps

MOYNIHAN
Intestinal Clamp
290mm

BIF 73



BIF 73

1/2

DENIS BROWNE
Intestinal Clamp, Angled
215mm

BIF 75



BIF 75

1/2

WILLIAMS
Grasping Forceps
160mm

BIF 28



BIF 28

1/2

DENIS BROWNE
Organ Tissue
Grasping Forceps,
Straight
180mm

BIF 76



BIF 76

1/2



Intestinal Clamps

KOCHERS Intestinal Clamp with Elastic Blades

Straight

BIF 80 - 210mm

BIF 81 - 230mm

BIF 82 - 250mm

Curved

BIF 80C - 210mm

BIF 81C - 230mm

BIF 82C - 250mm



BABY - KOCHERS Intestinal Clamp with Elastic Blades 150mm

BIF 94 - Straight

BIF 94C - Curved

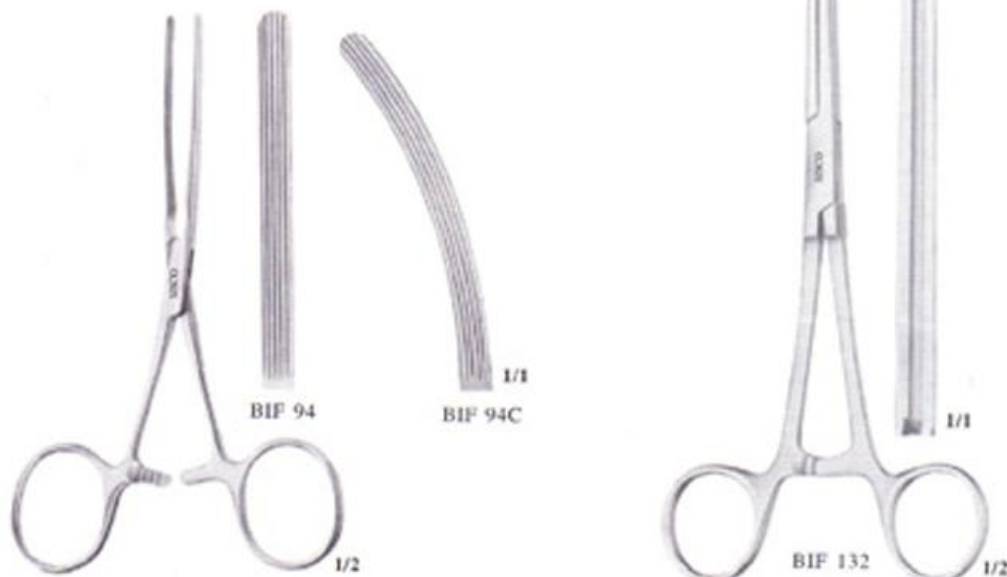

STEVENSON Intestinal Clamp 200mm

BIF 132



KOCHERS
Intestinal Clamp
Very Elastic
250mm

BIF 85 - Straight
BIF 85C - Curved



SHOE MAKER
Colectomy
Intestinal Clamp
Hollowed Blades
160mm

BIF 97 - 170mm
BIF 97A - 200mm

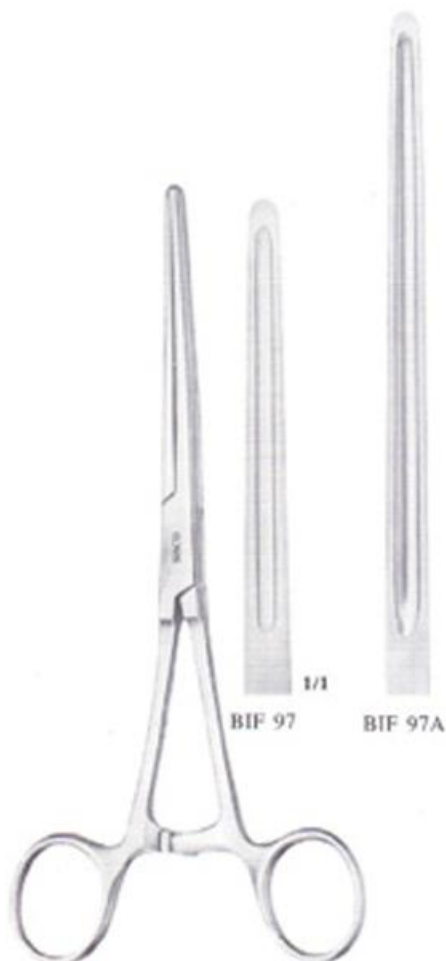

BAIN BRIDGE
Intestinal Clamp
150mm

BIF 93 - Straight
BIF 93C - Curved

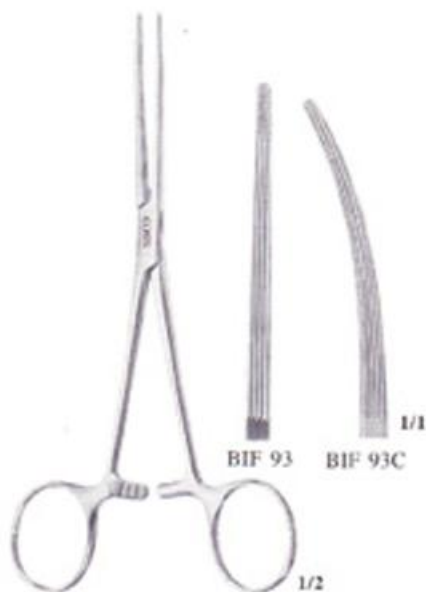

SHOE MAKER
Colectomy
Intestinal Clamp
160mm, With Pin

BIF 95

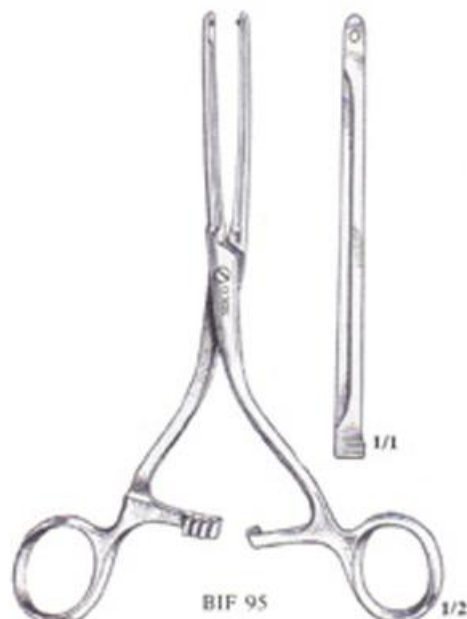



DOYENS
Intestinal Clamp
Atraumatic Jaw
With elastic Blades
240mm

BIF 86 - Straight
BIF 86C - Curved

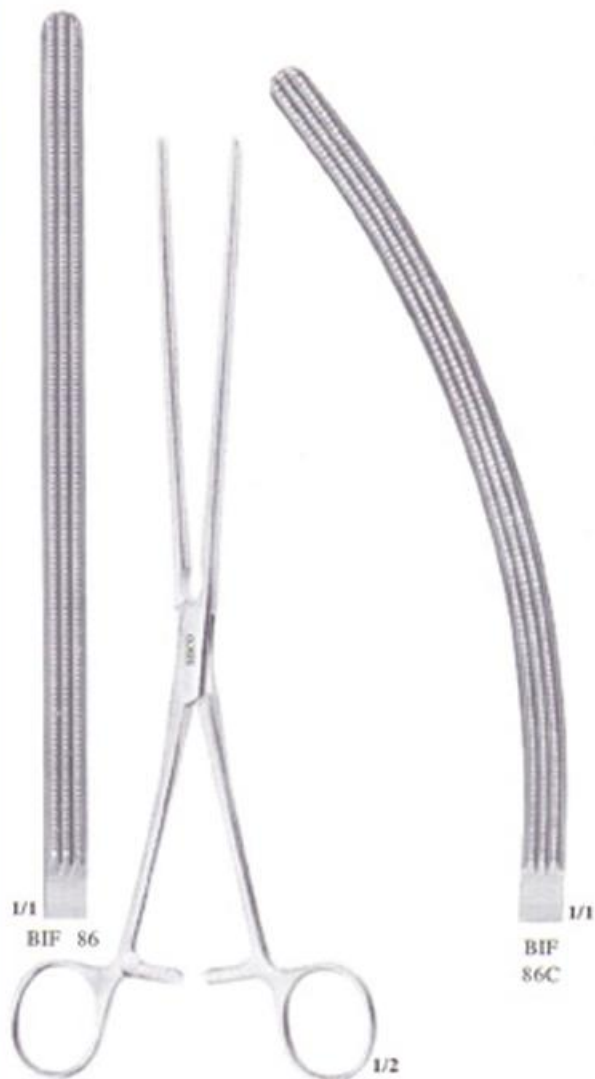

MAYO ROBSON
Intestinal Clamp
With Hard elastic
250mm

BIF 92 - Straight
BIF 92C - Curved

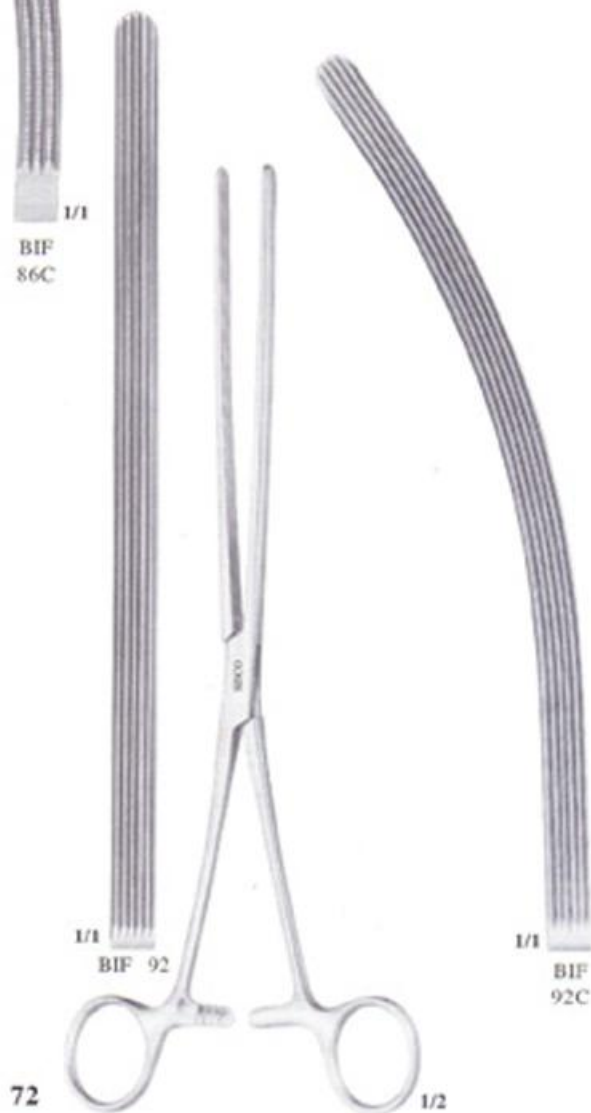



DOYENS
Mouth Gag
BAN 110



FERGUSSON
Mouth Gag
BAN 118



GENNINGS
Mouth Gag
BAN 120



HEISTER
Mouth Gag
BAN 125



TONGUE DEPRESSOR
BAN 163 - 13mm Small
BAN 164 - 19mm Medium
BAN 165 - 22mm Large

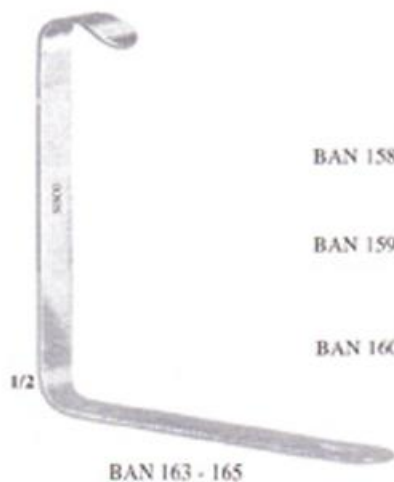

McGILLS
Forceps
BAN 158 - Small
BAN 159 - Medium
BAN 160 - Large

BAN 158 1/1

BAN 159 1/1

BAN 160 1/1





KILNER DOTTS
Mouth Gag
With 3 Tounge Blades
BAN 140



BAN 140



BAN 142

KILNER SUTURE
CARRIER
(To Fit On To BAN 140)
BAN 142

NORMAN DOTTS
Mouth Gag
With 2 Tounge Blades
BAN 154

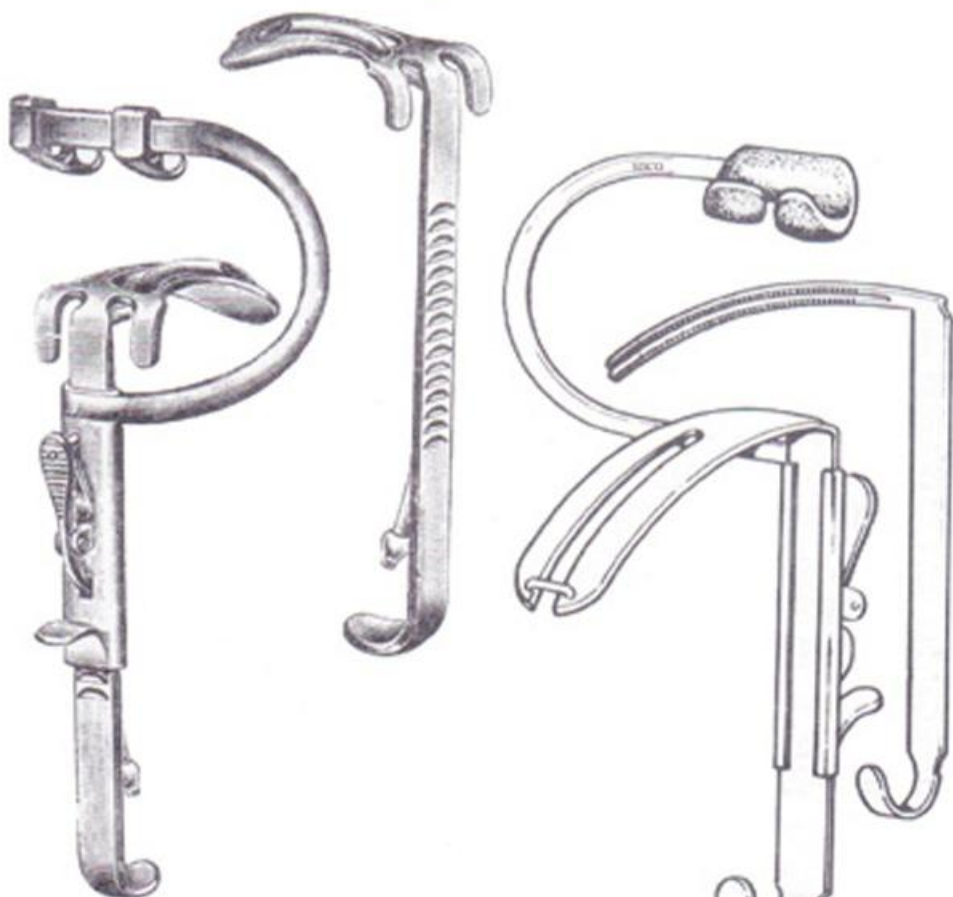

BAN 154

DOUGHTYS SLOTTED
Endotracheal Mouth Gag
With 5 Tounge Blades
BAN 141

BAN 141



DAVIS BOYLES
Mouth Gag
5 Tongue Blades With
Anaesthetic Tube
BAN 135



BAN 135

LANES
Mouth Gag
BAN 148 - Small
BAN 149 - Medium
BAN 150 - Large

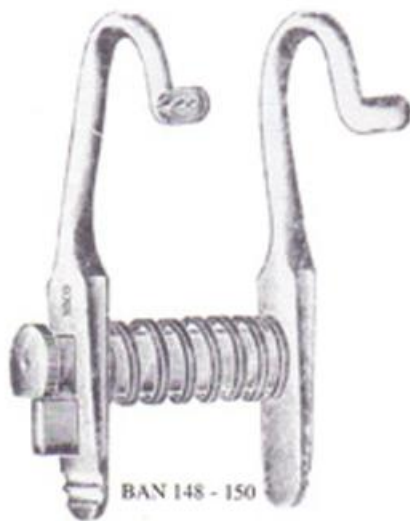

BAN 148 - 150

EAST GRINDSTEAD
MODEL
Davis Boyles Mouth Gag
With 3 Blades
BAN 143 - Left Frame
BAN 144 - Right Frame

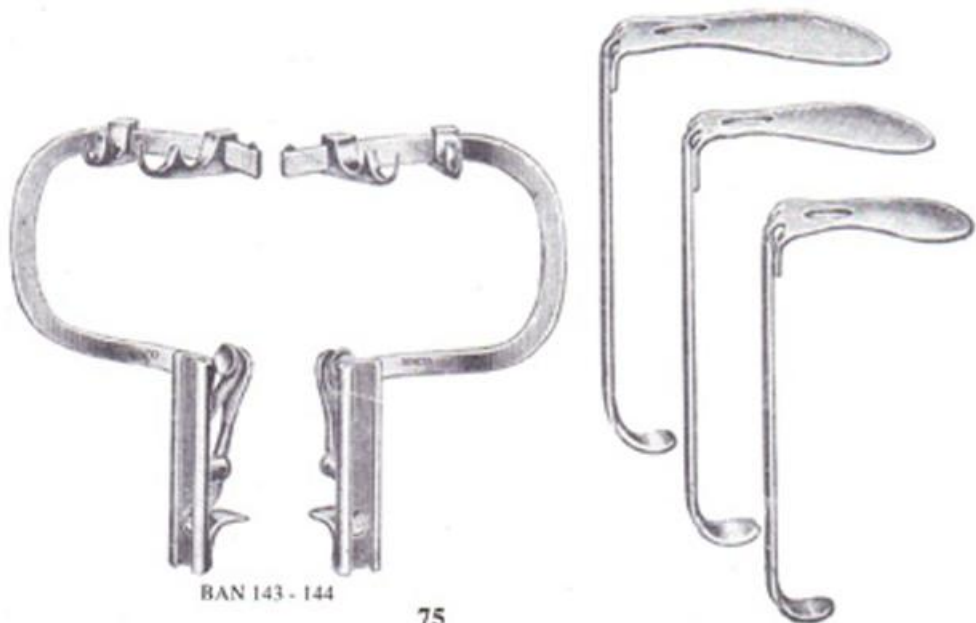

BAN 143 - 144

DAVIS BOYLES
Mouth Gag
With 5 Tounge Blades
BAN 130



DINGMANN
Mouth Gag
With 3 Blades
BAN 155





FARABEUF
Raspatories
140mm

BRP 175 - Straight
BRP 175C - Curved

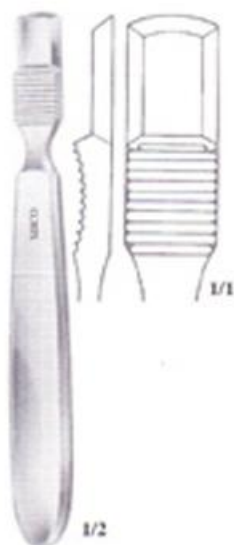

BRP 175

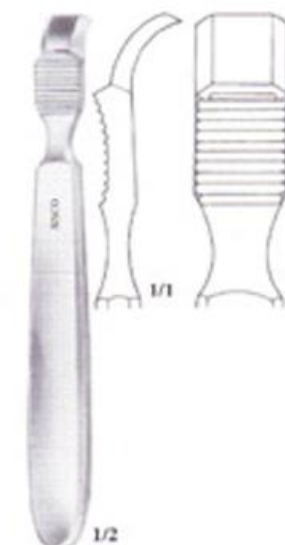

BRP 175C

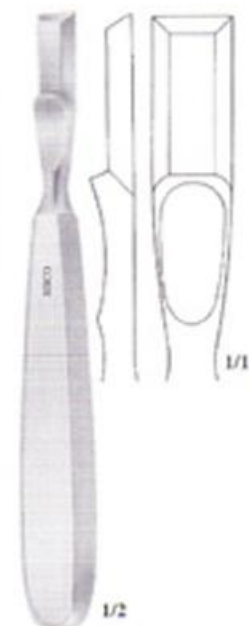

BRP 177



BRP 177C

FARABEUF COLLIN
Raspatories
155mm

BRP 177 - Straight
BRP 177C - Curved



BRP 180

BRP 181



BRP 182



BRP 183



BRP 184

ADSON
Raspatories
170mm

BRP 180 - 183

LANGENBECK
Raspatories
190mm

BRP 184



CLEFT PALATE
Raspatories, 170mm
BRP 212

BARSKY CLEFT
Raspatories, Double Ended
170mm
BRP 213

CLEFT PALATE
Raspatories, 130mm
BRP 214 - Left
BRP 215 - Right

McINDOE CLEFT PALATE
Raspatories, 180mm
BRP 216 - Small
BRP 217 - Medium
BRP 218 - Large

CLEFT PALATE
Raspatories, 140mm
BRP 219 - Upward
BRP 220 - Downward

JOSEPH NASAL
Raspatories, 180mm
BRP 221 - Up Cutting
BRP 222 - Down Cutting

MITCHELL TRIMMER
Raspatories, 180mm
BRP 223

SEPTUM
Raspatories, 180mm
BRP 224

BARSKY NASAL
Raspatories, 180mm
BRP 225D - Downward
BRP 225U - Upward

HOWARTH NASAL
Raspatories, Double Ended
230mm
BRP 226

PEAT NASAL
Raspatories, 180mm
BRP 227 - Straight
BRP 227C - Curved

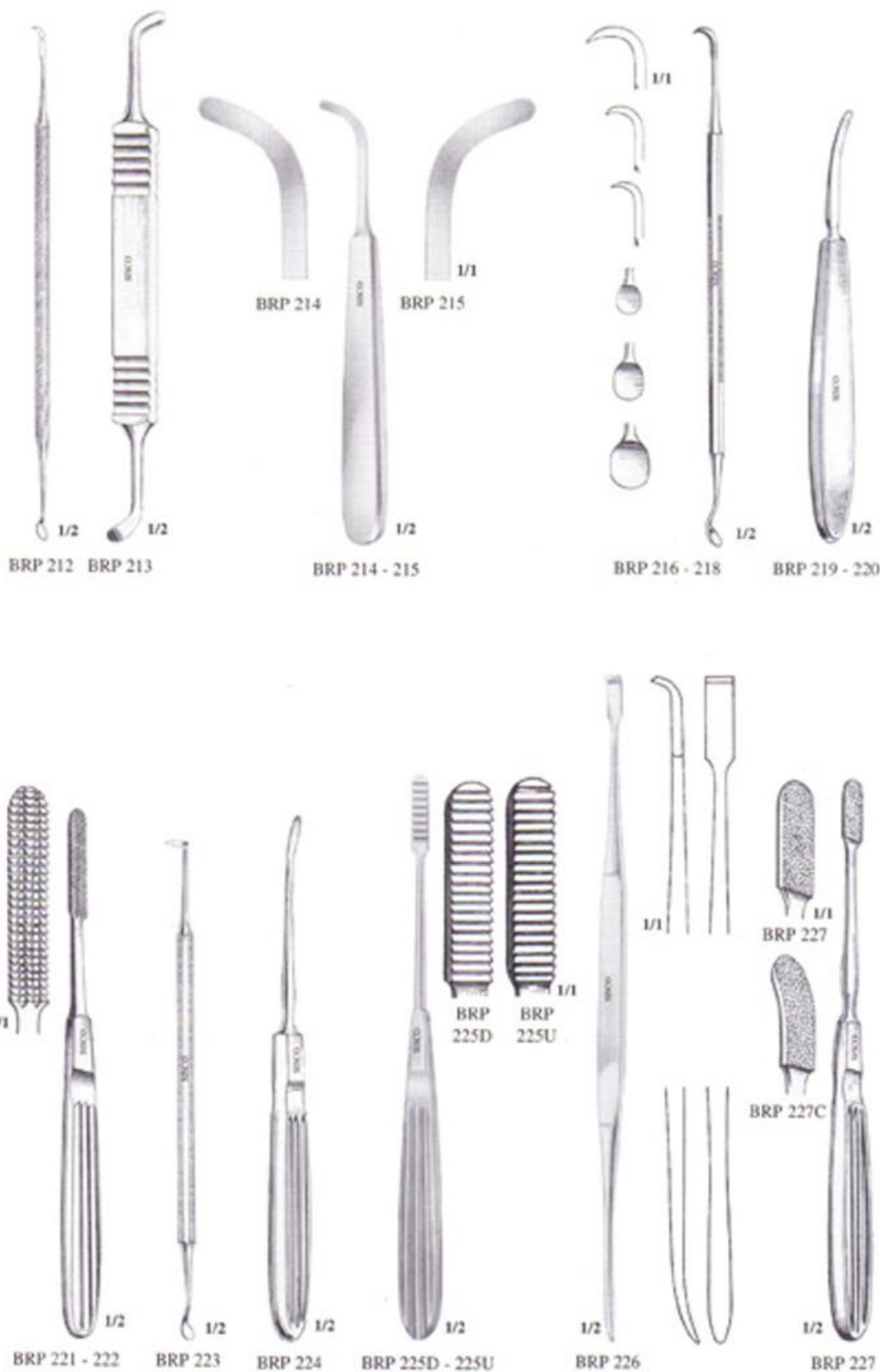



VOLKMANN
Curettes, Double Ended
230mm

BCR 247 - Small
BCR 248 - Medium
BCR 249 - Large

LEMPERT
Curettes, Fibre Handle
215mm

BCR 253-Fig. 0000 - 1.8mm
BCR 254-Fig.000 - 2mm
BCR 255-Fig.00 - 2.4mm
BCR 256-Fig.0 - 2.6mm

SCOVILLE
Curettes, Fibre Handle
250mm

BCR 250 - Straight
BCR 251 - Up
BCR 252 - Down

VOLKMANN
Curettes, Fibre Handle
170mm

BCR 261-Fig.0000 - 2.8mm
BCR 262-Fig.000 - 3.6mm
BCR 263-Fig.00 - 4.4mm
BCR 264-Fig.0 - 5.2mm
BCR 265-Fig.1 - 6.8mm
BCR 266-Fig.2 - 8.5mm
BCR 267-Fig.3 - 10mm
BCR 268-Fig.4 - 11.5mm
BCR 269-Fig.5 - 13mm
BCR 269A-Fig.6 - 14.5mm

JANSEN
Curette, Double Ended
160mm

BCR 803

ASH
Curette, Double Ended
180mm

BCR 817

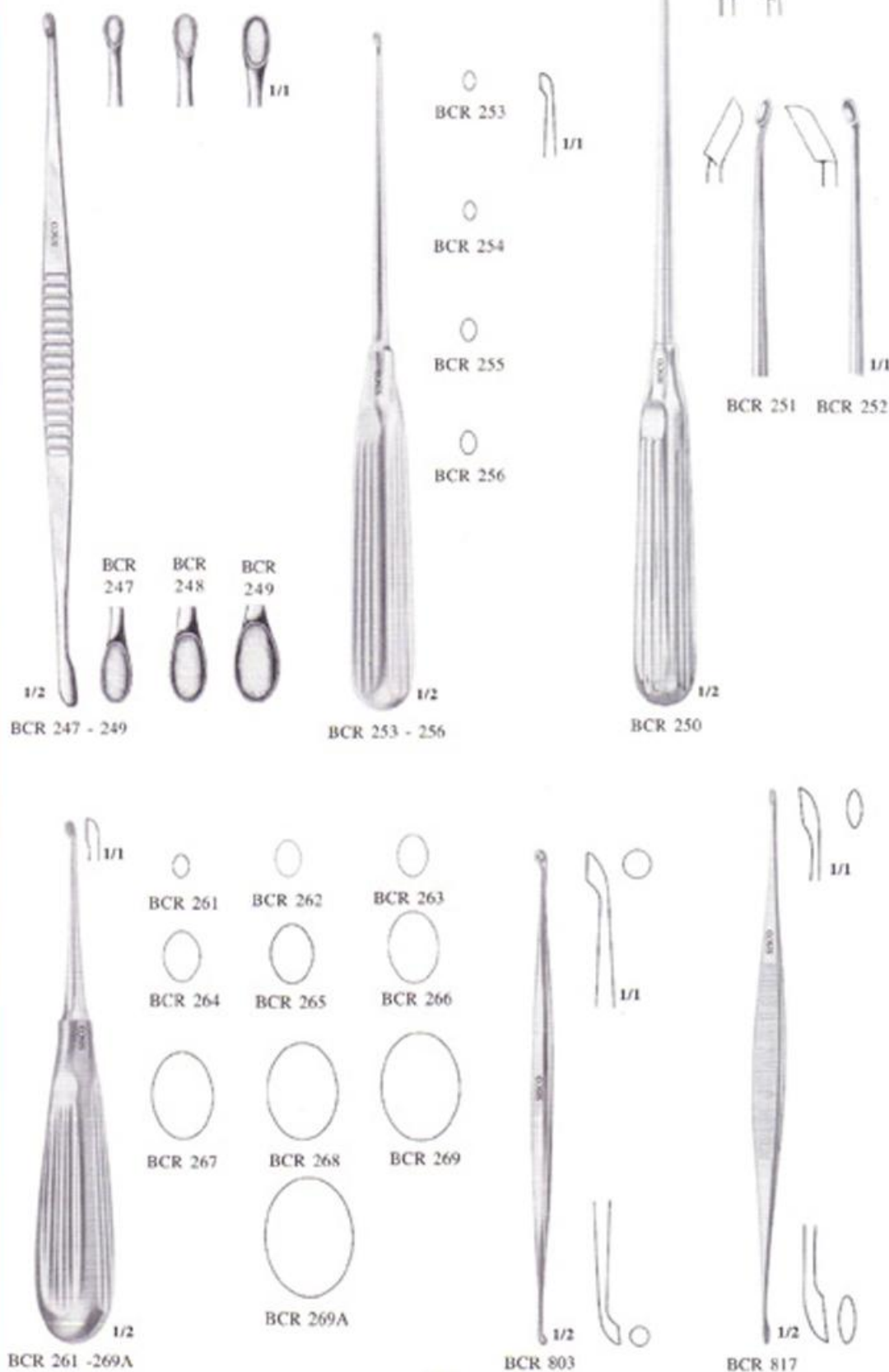



BECKMAN
Adenoid Curettes
Fibre Handle
200mm

BCR 270 - 275



BCR 270



BCR 271



BCR 272



BCR 273



BCR 274



1/1
BCR 275

ST. CLAIR THOMPSON
Adenoid Curettes
Fibre Handle
With Cage
215mm

BCR 276 - 8mm
BCR 277 - 10mm
BCR 278 - 12mm



BCR 276



BCR 277



1/1
BCR 278



SIMS
Curettes, Single Ended
Fibre Handle
255mm

BCR 241 - 246 - Blunt
BCR 241S - 246S - Sharp

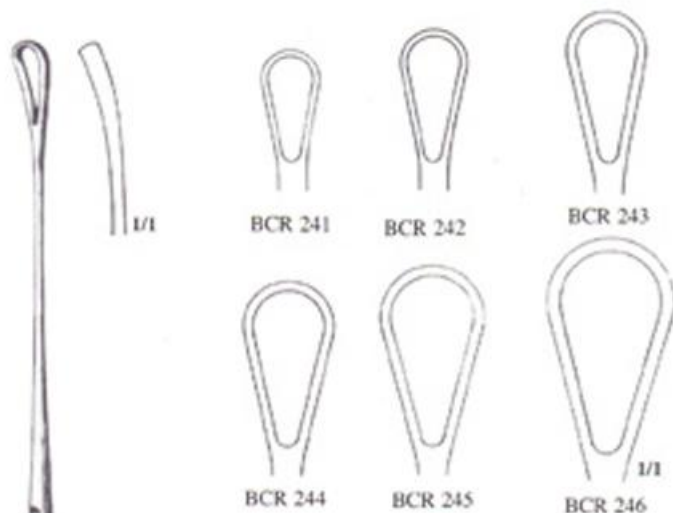

SIMS
Uterine Curettes,
Double Ended
Sharp & Blunt
275mm

BCR 240S - 8 x 5mm
BCR 240 - 10 x 7mm
BCR 240 L - 14 x 9mm

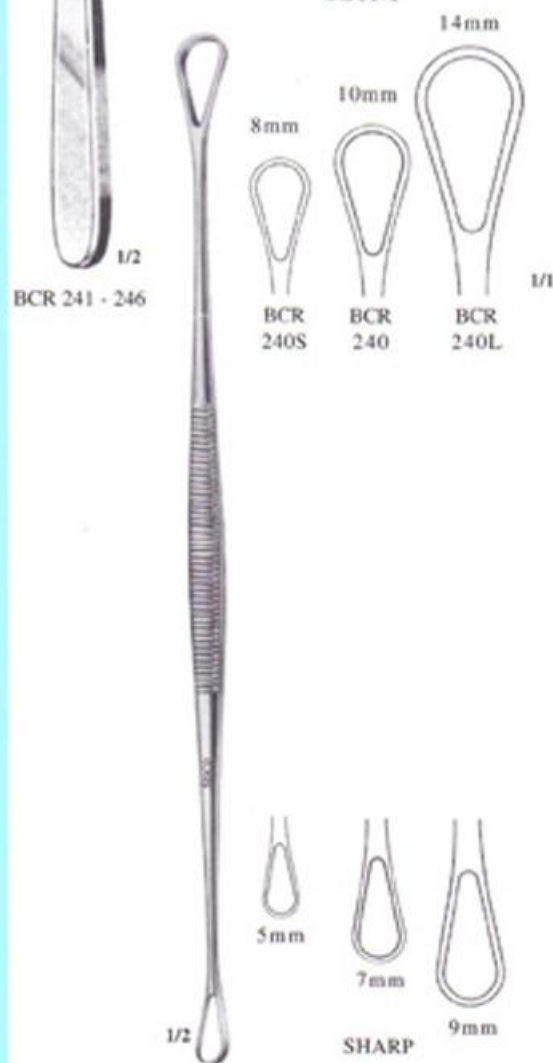

SCHROEDER
Curettes, Single Ended
Fibre Handle
310mm

BCR 234 - 239



CUSHING PERIOSTEAL

Sharp
Wid. 6mm, Leng. 200mm
BEL 270

LANGENBECK
PERIOSTEAL
200mm
BEL 185

ADSON PERIOSTEAL
Curved Blunt
Wid. 6mm, Leng. 170mm
BEL 277

CUSHING PERIOSTEAL
Wid. 6mm, Leng. 200mm
BEL 272

LANGENBECK
PERIOSTEAL
Wid. 16mm, Leng. 185mm
BRP 185

CUSHING PERIOSTEAL
Wid. 15mm, Leng. 195mm
BEL 275

ADSON PERIOSTEAL
Chisel Edge
Wid. 8mm, Leng. 165mm
BEL 276

HOEN PERIOSTEAL
Wid. 7mm, Leng. 185mm
BRP 277

ADSON PERIOSTEAL
Cvd. Semi-Sharp
Wid. 6mm, Leng. 165mm
BEL 278

CUSHING
STAPHYLORRHAPHY
Wid. 6mm, Leng. 200mm,
BEL 279

CUSHING PERIOSTEAL
Sharp
Wid. 18mm, Leng. 190mm
BEL 274

CLOWARD PERIOSTEAL
Sharp
Wid. 5mm, Leng. 200mm
BEL 283



BEL 270



BEL 185



BEL 277



BEL 272



BRP 185



BEL 275



BEL 276



BRP 277



BEL 278



BEL 279



BEL 274



BEL 283



ADSON PERIOSTEAL
Elevators, Sharp
Wid. 5mm, Leng. 165mm
BEL 300



LANDOLT PERIOSTEAL
Elevators, Semi-Sharp
Wid. 5mm, Leng. 175mm
BEL 314

COTTLE PERIOSTEAL
Elevators, Semi-Sharp
Wid. 8mm, Leng. 195mm
BEL 157

CASPAR PERIOSTEAL
Elevators, Sharp
Wid. 6mm, Leng. 180mm
BEL 328

CASPAR PERIOSTEAL
Elevators, Semi-Sharp
Wid. 6mm, Leng. 180mm
BEL 329

ADSON PERIOSTEAL
Elevators
Wid. 5mm, Leng. 165mm
BEL 299





DOUBLE ENDED
Elevators, Spoon Shaped
180mm

BEL 280



BEL 280

DOUBLE ENDED
Elevators
Angled Left & Right
180mm

BEL 282



BEL 282

DOUBLE ENDED
Elevators
Angled To Side On Flat
180mm

BEL 284



BEL 284



BEL 285

BARSKY PHARYNGEAL
Flap Elevators
180mm

BEL 285



READ PERIOSTEAL
Elevators
Double Ended
215mm

BEL 290



BEL 290

MATSON PERIOSTEAL
Elevators
230mm

BEL 292



BEL 292

BRISTOW PERIOSTEAL
Elevators
230mm

BEL 298



BEL 298



Bone Hooks

KOCHER
Bone Hook, Sharp
205mm
BBT 234

KOCHER
Bone Hook, Sharp
220mm
BBT 238

KOCHER
Bone Hook, Blunt
220mm
BBT 239

VOLKMANN
Bone Hook, Sharp
220mm
BBT 240

VOLKMANN
Bone Hook, Blunt
220mm
BBT 241

VOLKMANN
Bone Hook, Sharp
245mm
BBT 232

VOLKMANN
Bone Hook, Sharp
220mm
BBT 221

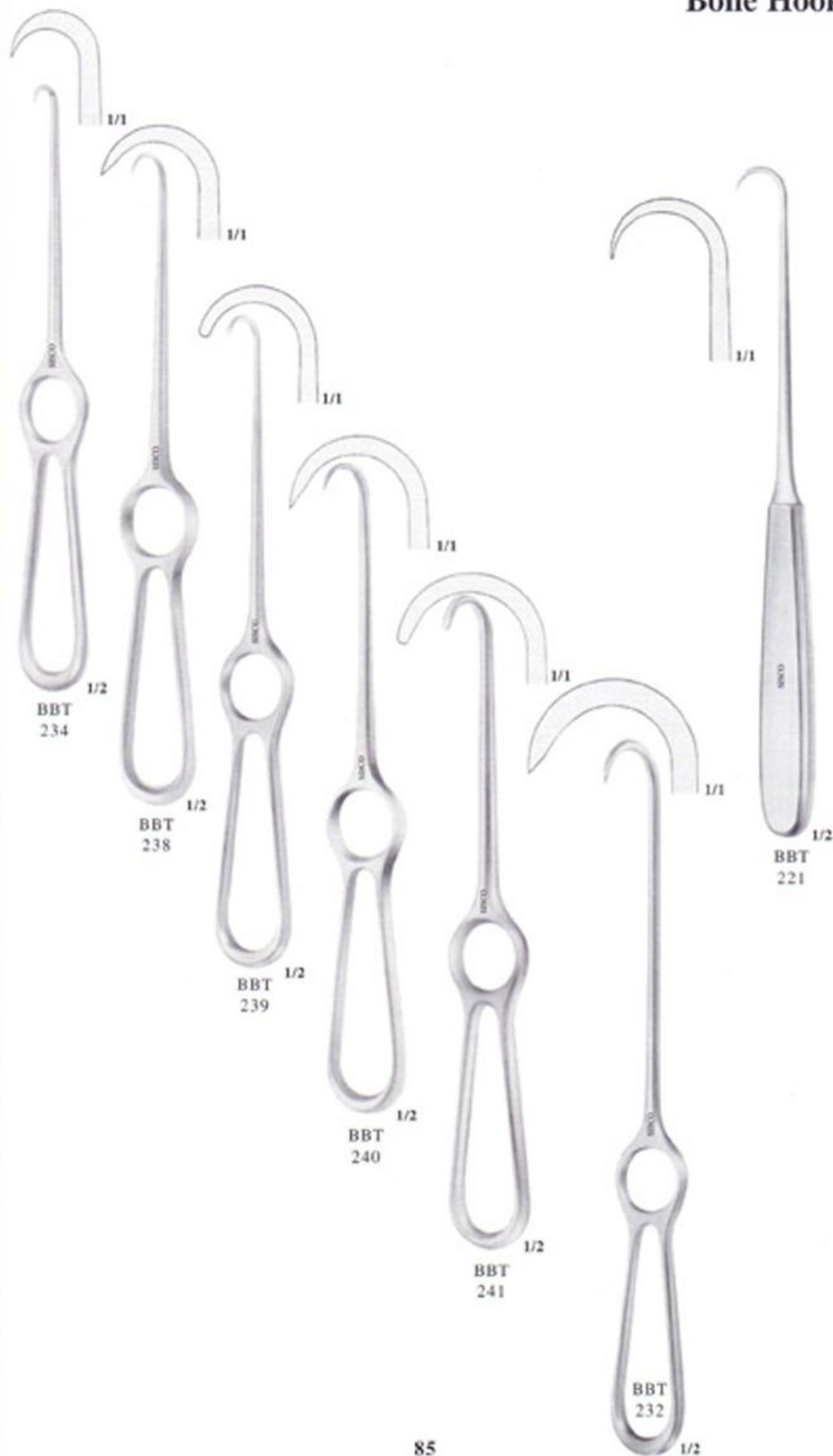



STILLE Osteotomes, 200mm

Straight

- BCH 401 - 6mm
- BCH 402 - 12mm
- BCH 403 - 18mm
- BCH 404 - 24mm
- BCH 405 - 36mm
- BCH 406 - 49mm

Curved

- BCH 401C - 6mm
- BCH 402C - 12mm
- BCH 403C - 18mm
- BCH 404C - 24mm
- BCH 405C - 36mm
- BCH 406C - 49mm

STILLE Chisels, 200mm

Straight

- BCL 421 - 6mm
- BCL 422 - 12mm
- BCL 423 - 18mm
- BCL 424 - 24mm
- BCL 425 - 36mm
- BCL 426 - 49mm



BCH 401 - 406



BCH 401C - 406C



BCL 421 - 426

DURRAY READ Osteotomes, 180mm

- BCH 410 - 2mm
- BCH 411 - 3mm
- BCH 412 - 4mm
- BCH 413 - 5mm

DURRAY READ Chisels, 180mm

- BCL 440 - 2mm
- BCL 441 - 3mm
- BCL 442 - 4mm
- BCL 443 - 5mm

JENKINS Chisels, 140mm

- BCL 430 - 2mm
- BCL 431 - 4mm
- BCL 432 - 6mm
- BCL 433 - 8mm
- BCL 434 - 10mm
- BCL 435 - 12mm



BCH 410 - 413



BCL 440 - 443



BCL 430 - 435



STILLE

Gouges, 200mm

BCL 451 - 10mm

BCL 452 - 12mm

BCL 453 - 15mm

BCL 454 - 20mm

BCL 455 - 25mm

DURRAY READ

Gouges, 180mm

BCL 467 - 2mm

BCL 468 - 3mm

BCL 469 - 4mm

BCL 470 - 5mm

JENKINS

Gouges, 140mm

BCL 460 - 3mm

BCL 461 - 4mm

BCL 462 - 6mm

BCL 463 - 8mm

BCL 464 - 10mm

KILLIANS NASAL

Gouges, 150mm

BCL 474 - 6mm

TILLEY NASAL

Gouges, 150mm

BCL 476 - 6mm

COTTLE

Osteotomes, 180mm

BCL 294 - 4mm

BCL 295 - 6mm

BCL 296 - 8mm

BCL 297 - 10mm

BCL 298 - 12mm

COTTLE

Chisels, 180mm

BCH 301 - 4mm

BCH 302 - 6mm

BCH 303 - 8mm

BCH 304 - 10mm

BCH 305 - 12mm

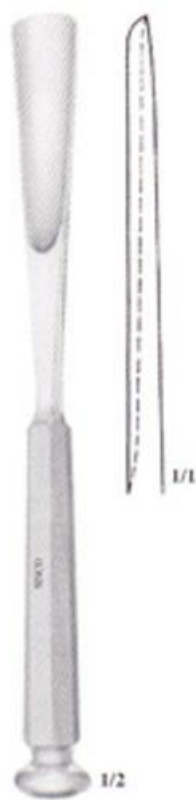

BCL 451 - 455



BCL 467 - 470



BCL 460 - 464



BCL 474



BCL 476



BCL 294 - 298



BCH 301 - 305



Bone Holding Forceps

SEQUESTRUM
Bone Holding Forceps
200mm

BBF 308 - Straight
BBF 308C - Curved



BBF 308



BBF 308C



BBF 310

FERGUSSON
Bone Holding Forceps
210mm

BBF 310

SEMB
Bone Holding Forceps
190mm

BBF 313



BBF 313



1/1



BBF 325

VERBRUGGE
Self Centering
Bone Holding Forceps
190mm

BBF 325



Bone Holding Forceps

KERN-LANE
Bone Holding Forceps
230mm

BBF 158



LANE
Bone Holding Forceps
330mm

BBF 318





Bone Holding Forceps

LANE
Bone Holding Forceps
330mm
BBF 314

KERN-LANE
Bone Holding Forceps
240mm
BBF 150

VERBRUGGE
Bone Holding Forceps
175mm
BBF 180



LANGENBECK

Bone Levers

230mm

BFK 131



BFK 131

LANGE-HOHMANN

Bone Levers

BFK 160 - 24mm X 250mm

BFK 161 - 30mm X 265mm

BFK 162 - 33mm X 280mm

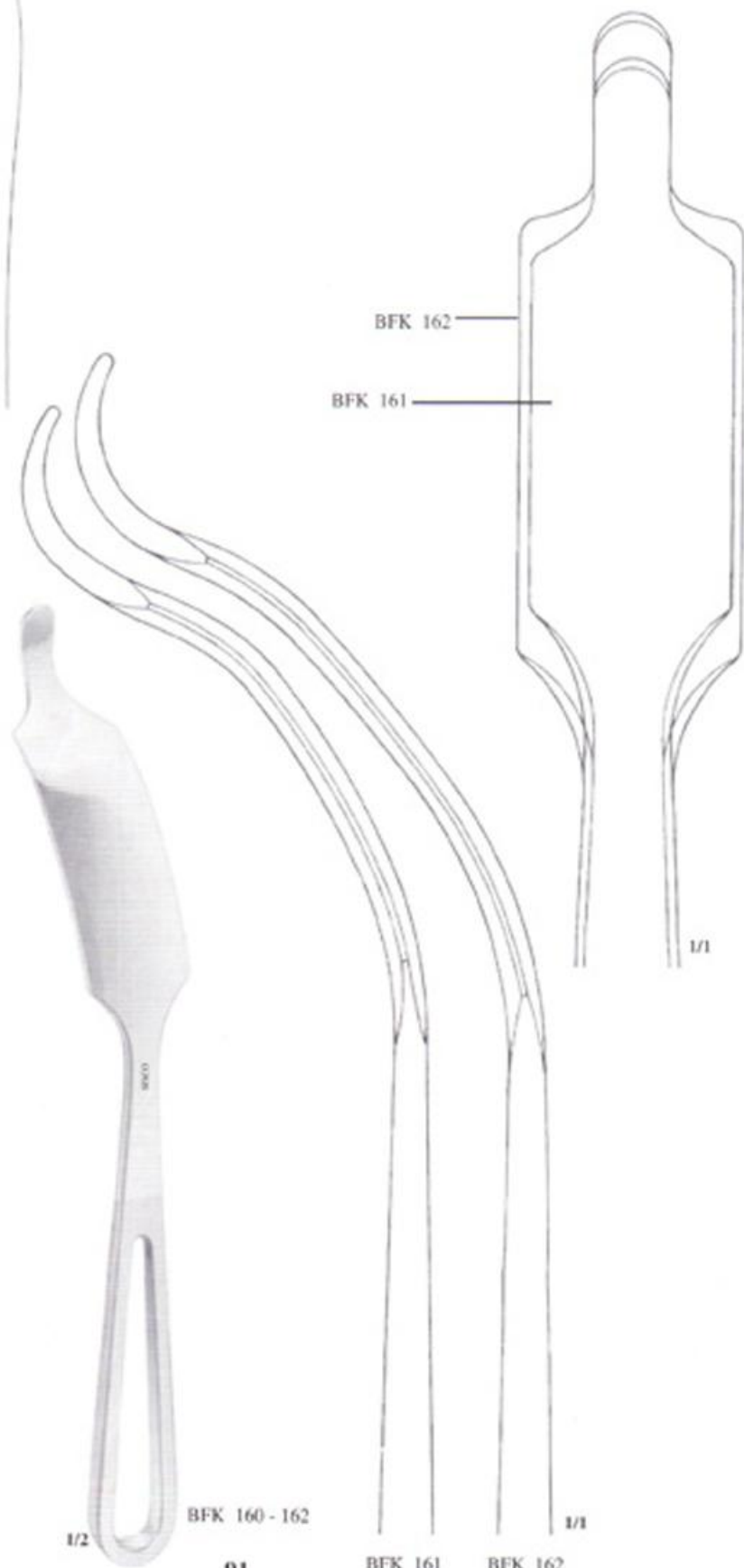

BFK 160 - 162

1/2

91

BFK 161

BFK 162

1/1

VERBRUGGE-MULLER
Bone Levers

BFK 174 - 44mm X 240mm
BFK 175 - 65mm X 255mm

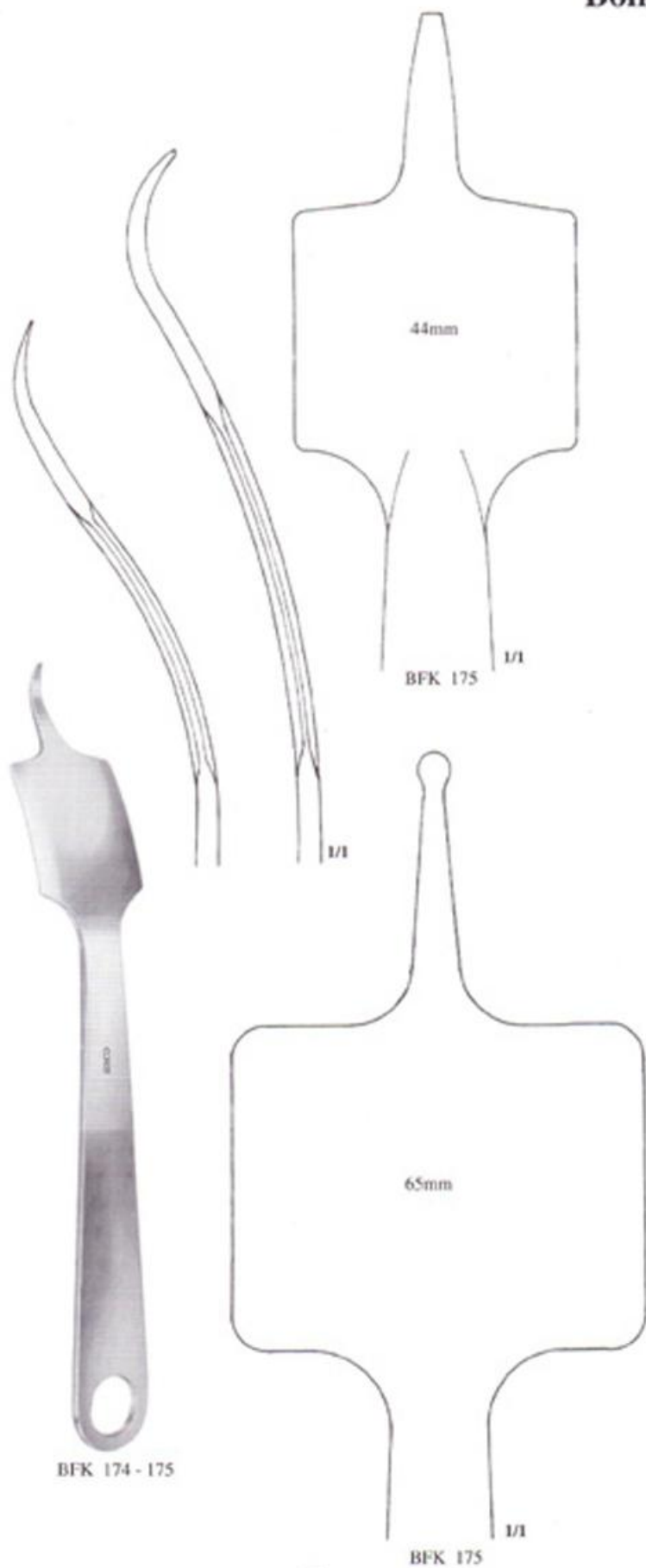

BFK 174 - 175

BFK 175

**HOHMANN
Bone Levers**

BFK 172 - 24mm X 260mm

BFK 173 - 34mm X 285mm

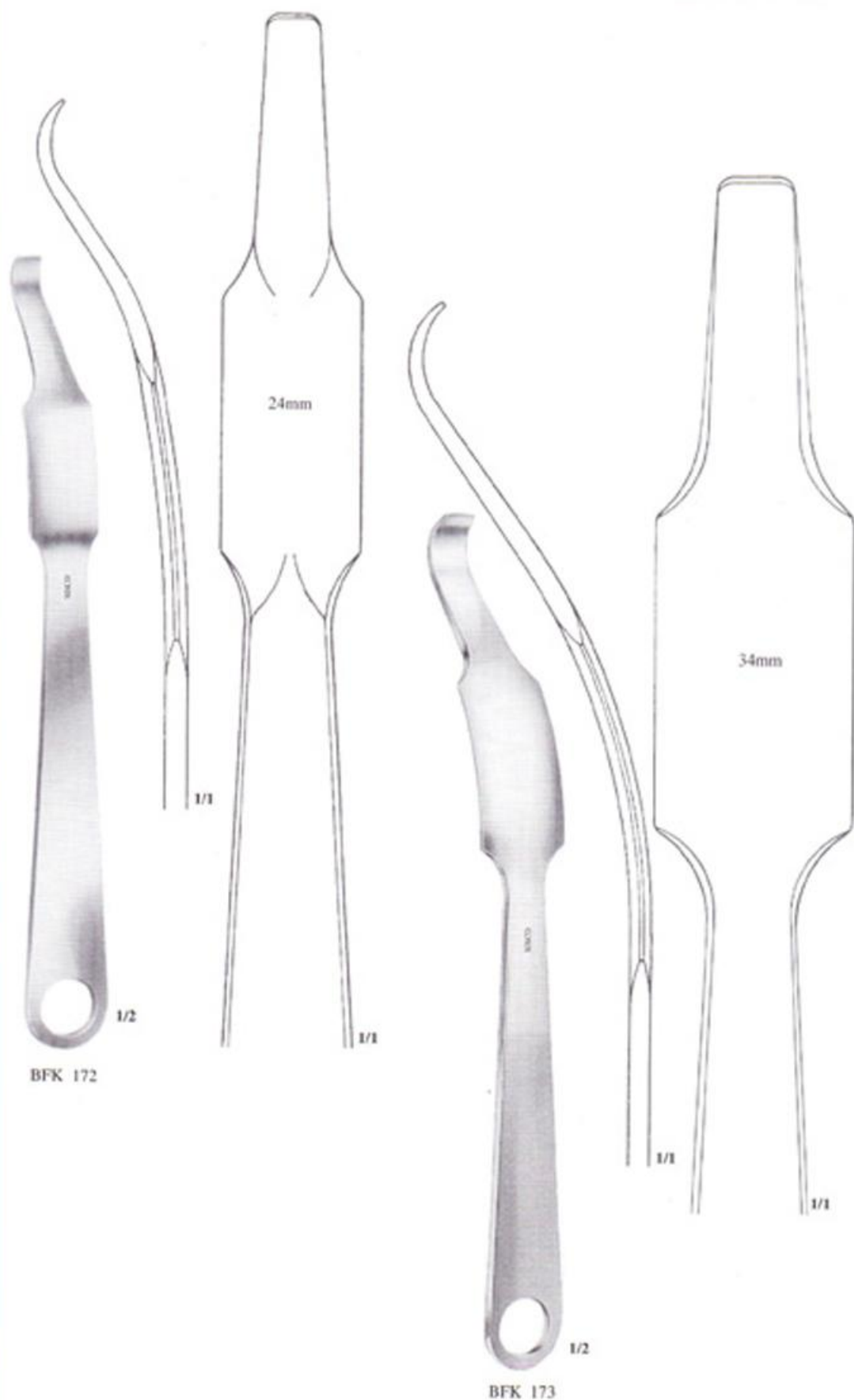

BFK 172

BFK 173



BUCK
Bone Levers
160mm
BFK 117



BUCK
Bone Levers
160mm
BFK 118

WAGNER
Bone Levers
10mm X 220mm
BFK 170



WAGNER
Bone Levers
17mm X 240mm
BFK 171



Bone File
One Side File Cut
One Side Rasp Cut
220mm

BFK 507

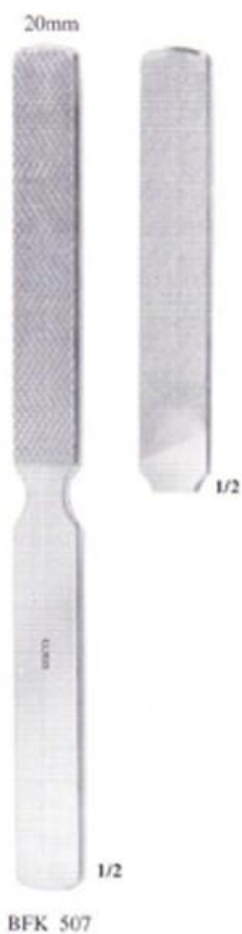

Bone File
Fibre Handle
295mm

BFK 510



Bone File
Fibre Handle
240mm

BFK 511





HAJEK
Mallet - Fibre Handle
Weight 165g.

BFL 144

HEATH
Mallet
Weight 700g.

BFL 68

COTTLE
Mallet
Weight 240g.

BFL 38

BERGMANN
Mallet
Weight 300g.

BFL 55

HAJEK
Mallet - Fibre Handle
Weight 140g.

BFL 44

OMBREDANNE
Mallet
Weight 550g.

BFL 66

Mallets



BFL 144



BFL 68



BFL 38



BFL 55



BFL 44



BFL 66



Bone Awl & Meniscus Knives

ESMARCH
Bone Awl - Fibre Handle
With 2 Drill Points
200mm

BFR 100



BONE AWL
With Eye - Fibre Handle
170mm

BFR 101



BFR 100

BFR 101

BFR 102

BONE AWL
Without Eye - Fibre Handle
150mm

BFR 102



SMILLIE
Meniscus Knives
170mm

BFO 855



SMILLIE
Meniscus Knives
170mm

BFO 856



SMILLIE
Meniscus Knives
170mm

BFO 857



BFO 855



BFO 856



BFO 857



GLASGOW
Bone Rongeur
Single Action
145mm

BBF 327



BBF 327

JANSEN
Bone Rongeur
Single Action
175mm

BBF 330 - Straight
BBF 330C - Curved



BBF 330 - 330C

LEMPERT
Bone Rongeur
Single Action
175mm

BBF 328 - Straight
BBF 328C - Curved

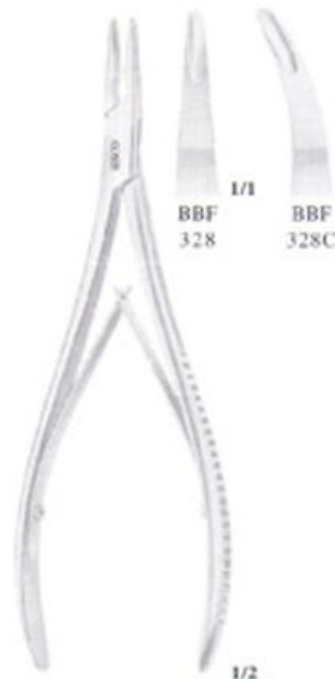

BBF 328 - 328C

MEAD
Bone Rongeur
Single Action
165mm

BBF 455



BBF 455

LUER
Bone Rongeur, Heavy
Single Action
175mm

BBF 460 - Straight
BBF 460C - Curved

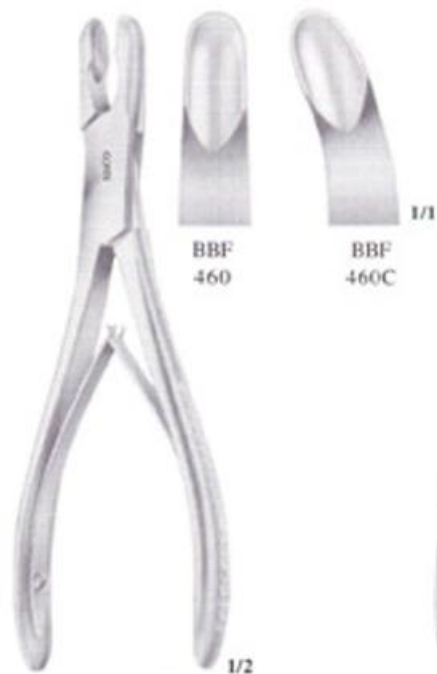

BBF 460 - 460C

BEYER
Bone Rongeur
Single Action
180mm

BBF 453

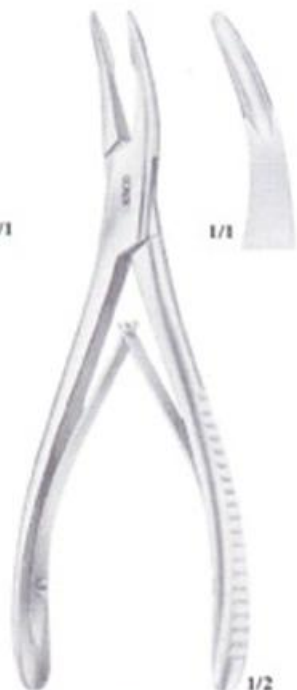

BBF 453



Bone Rongeurs

LEKSELL STILLE

Bone Rongeur
Double Action
243mm
BBF 340



STILLE
Bone Rongeur
Double Action
230mm
BBF 345

STILLE RUSKIN
Bone Rongeur
Double Action
240mm
BBF 346

LUER-STILLE
Bone Rongeur
Double Action Straight
230mm
BBF 343



LUER-STILLE
Bone Rongeur
Double Action Curved
230mm
BBF 344



McINDOE
Bone Cutter
Double Action
180mm
BBF 377



Bone Cutters & Wire Cutter

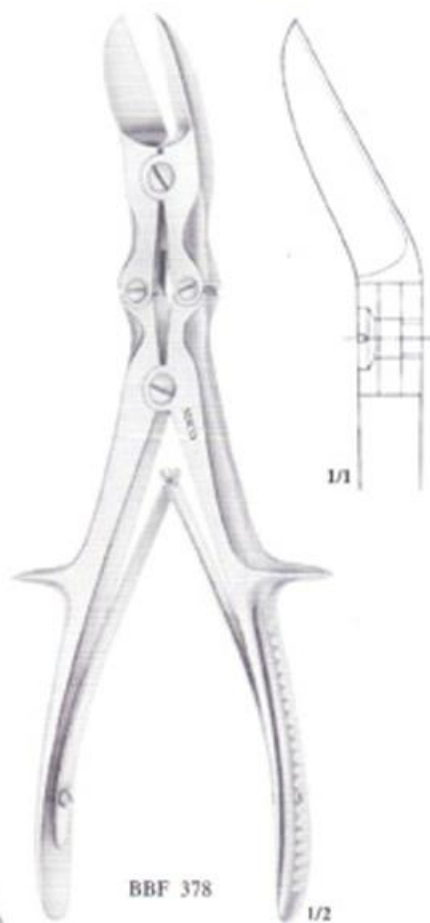

LISTON
Bone Cutter
Double Action Angled
235mm
BBF 378

LISTON
Bone Cutter
Double Action
265mm
BBF 379 - Straight
BBF379C - Curved



REILL
Wire Cutter
Double Action
175mm
BBF 159

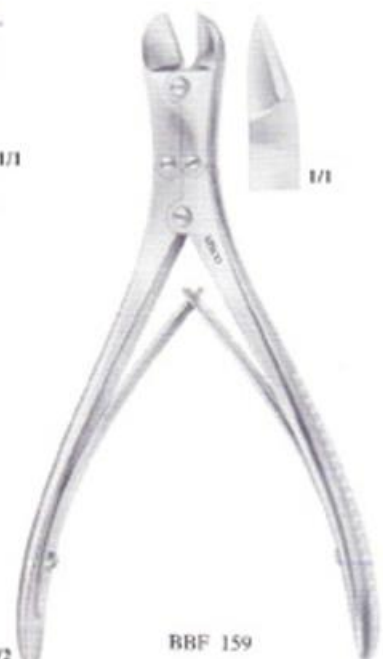



RUSKIN - LISTON
Bone Cutter
Double Action
190mm

BBF 640

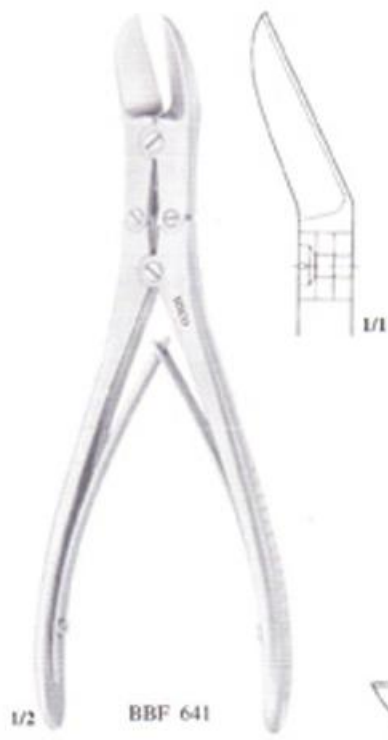

RUSKIN - LISTON
Bone Cutter
Double Action Angled
190mm

BBF 641

ASH
Bone Cutter
Single Action
225mm

BBF 632

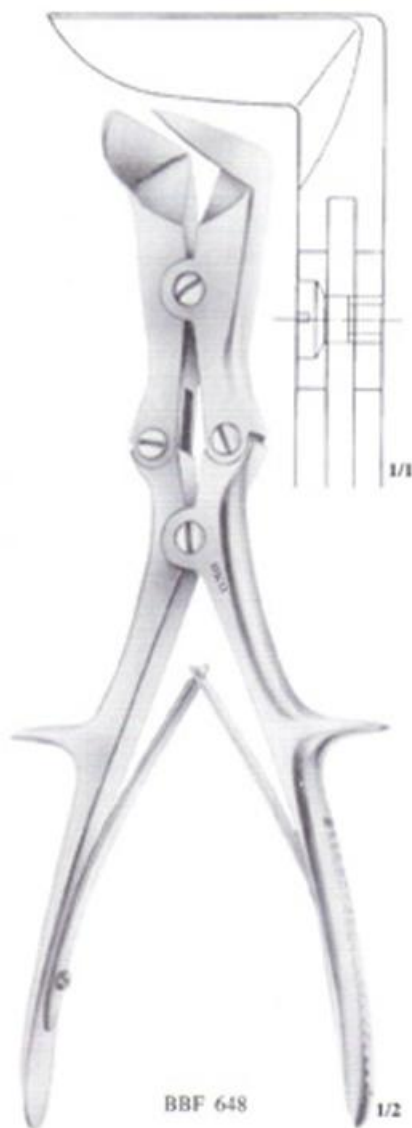
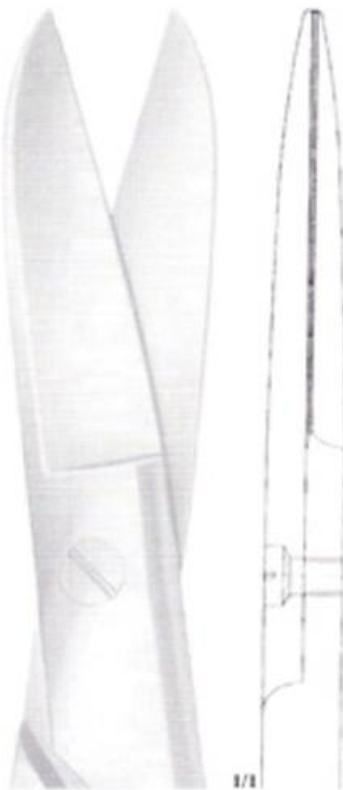

LISTON STILLE
Bone Cutter, 90 Deg. Ang.
Double Action
265mm

BBF 648

SEMB
Bone Cutter
Double Action
Curved To Sideways
250mm

BBF 388



1/2

BBF 388

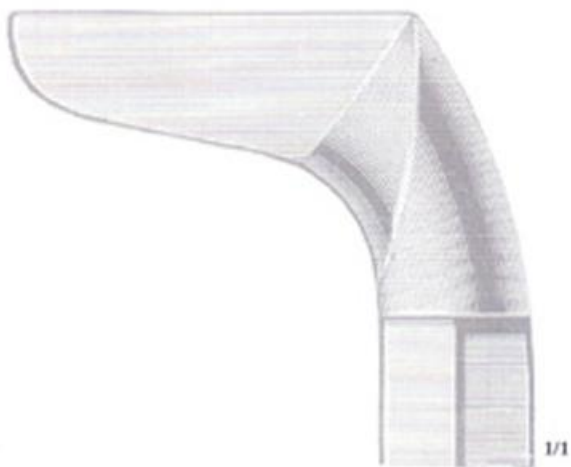

1/1

TUDOR EDWARD
Bone Cutter
Double Action
260mm

BBF 386

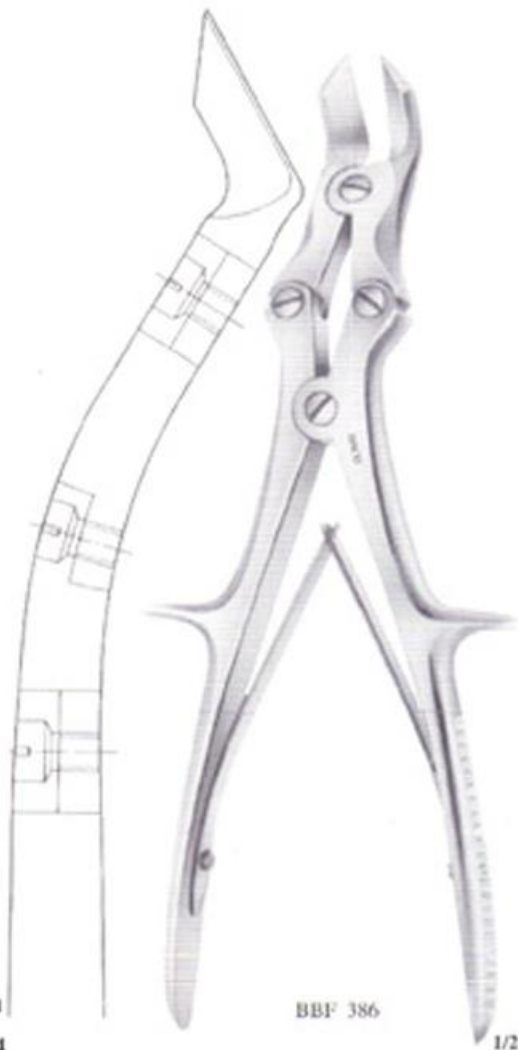

1/1

BBF 386

104

1/2



HUMBYS
Skin Grafting Knives
Fibre Handle
300mm
BSK 172



BSK 172

SILVERS
Skin Grafting Knives
Fibre Handle
190mm
BSK 170



BSK 170

Skin Grafting Measure
BSK 173



BSK 173



Nose Pliers, Plaster Shears & Spreader

WIRE HOLDING

Forceps with serrated
Jaws
140mm

BWP 131

WIRE HOLDING

Forceps One jaw smooth
and One jaw serrated
140mm

BWP 135

WIRE TIGHTENING

Pliers Serrated jaws
170mm

BWP 170

WIRE TIGHTENING

Pliers Longitudinal and
Transversal Grooves
170mm

BWP 171

WIRE FLAT NOSED

Pliers
190mm

BWP 172

STILLE

Plaster Shears
230mm

BOM 867

STILLE

Plaster Shears
370mm

BOM 866

HENNIG

Plaster Spreader
270mm

BOM 869

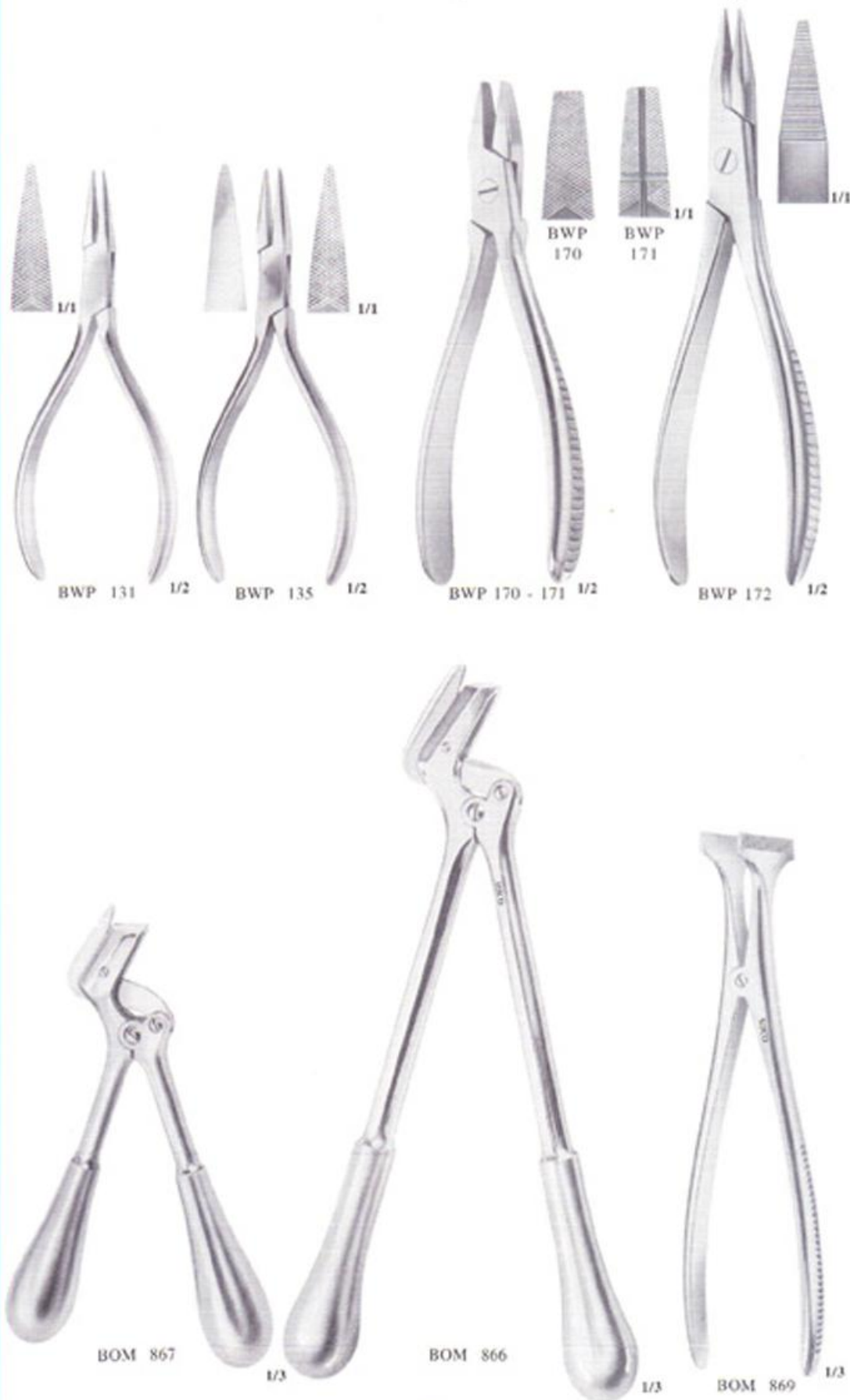



BOM 870

NABATOFF
Vein Strippers
BOM 870

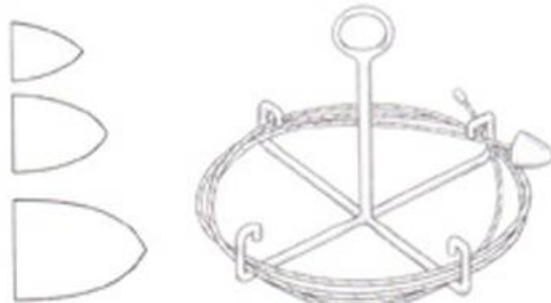

BOM 871

FOOTES
Vein Strippers
BOM 871



SISCO STERILE
CONTAINER
280 x 280 x 65mm

SCM



BOWL LIFTING
FORCEPS
350mm

BOM 876



SCM

SYRINGE HOLDING
FORCEPS
200mm

BOM 826



1/3

BOM 876



1/2

BOM 826



1/2

BOM 817 - 820

CHEATELE FORCEPS
200mm

BOM 817 - 150mm

BOM 818 - 200mm

BOM 819 - 250mm

BOM 820 - 300mm

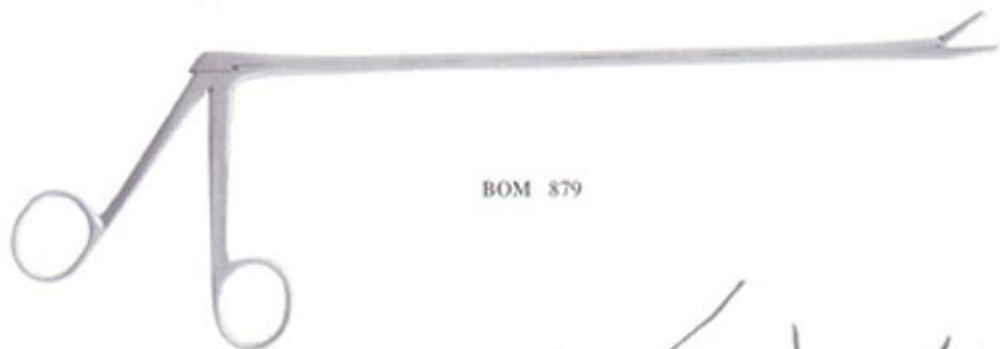

BOM 879

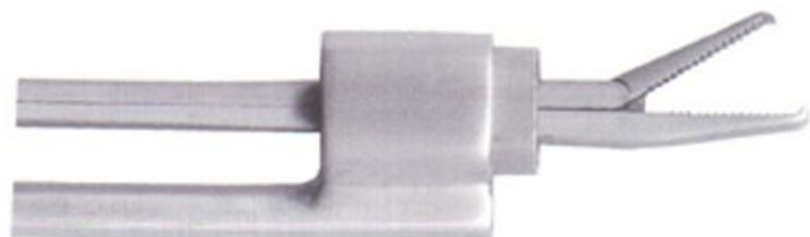
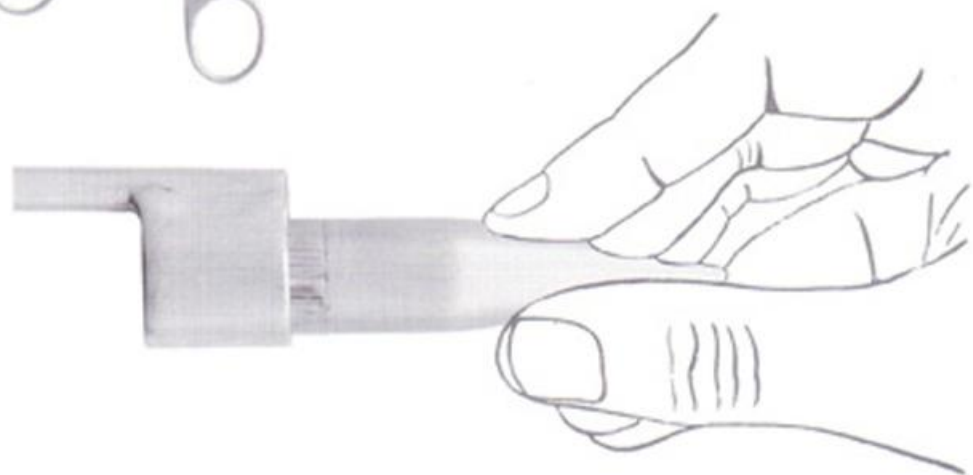

HAEMORRHOIDAL
Ligating Forceps & Gun
BOM 879

ANDERSON
Tenden Tunneling Forceps

Straight

- PGR 405 - 150mm
- PGR 406 - 180mm
- PGR 407 - 200mm
- PGR 408 - 230mm
- PGR 409 - 250mm
- PGR 410 - 275mm
- PGR 411 - 300mm
- PGR 412 - 350mm

Curved

- PGR 405C - 150mm
- PGR 406C - 180mm
- PGR 407C - 200mm
- PGR 408C - 230mm
- PGR 409C - 250mm
- PGR 410C - 275mm
- PGR 411C - 300mm
- PGR 412C - 350mm



PGR 405 - 412



PGR 405C - 412C



Amputation Saw

AMPUTATION SAW

Blade Length 35cm

BAS 135



BAS 135

AMPUTATION SAW

Blade Length 24cm

BAS 124



BAS 124

AMPUTATION SAW

With Hinged Back

Blade Length 19cm

BAS 119

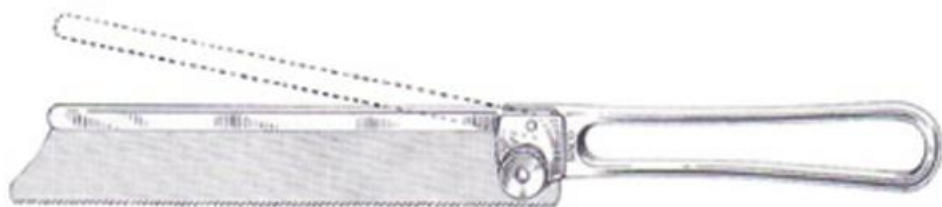

BAS 119

FINGER SAW

Blade Length 10cm

BAS 110



BAS 110



Numerical Index

Code No	Page No	Code No	Page No
BAN 110	73	BBF 310	88
BAN 118	73	BBF 313	88
BAN 120	73	BBF 314	90
BAN 125	73	BBF 318	89
BAN 130	76	BBF 325	88
BAN 135	75	BBF 327	98
BAN 140	74	BBF 328	98
BAN 141	74	BBF 328C	98
BAN 142	74	BBF 330	98
BAN 143	75	BBF 330C	98
BAN 144	75	BBF 333	99
BAN 148	75	BBF 340	100
BAN 149	75	BBF 341	99
BAN 150	75	BBF 342	99
BAN 154	74	BBF 343	100
BAN 155	76	BBF 344	100
BAN 158	73	BBF 345	100
BAN 159	73	BBF 346	100
BAN 160	73	BBF 347	99
BAN 163	73	BBF 360	101
BAN 164	73	BBF 374	101
BAN 165	73	BBF 375	101
BAP 830	54	BBF 376	101
BAP 835	54	BBF 377	102
BAP 857	54	BBF 378	102
BAP 858	54	BBF 379	102
BAP 859	54	BBF 379C	102
BAR 602	4	BBF 386	104
BAR 606	3	BBF 388	104
BAR 608	3	BBF 411	101
BAR 610	3	BBF 453	98
BAR 615	4	BBF 455	98
BAR 620	4	BBF 460	98
BAR 625	5	BBF 460C	98
BAR 630	5	BBF 518	99
BAR 640	6	BBF 521	99
BAR 641	6	BBF 632	103
BAR 642	6	BBF 633	101
BAR 645	6	BBF 634	101
BAR 646	6	BBF 635	101
BAS 110	111	BBF 640	103
BAS 119	111	BBF 641	103
BAS 124	111	BBF 648	103
BAS 135	111	BBP 103	1
BBF 150	90	BBP 103L	1
BBF 158	89	BBP 104	2
BBF 159	102	BBP 104L	2
BBF 180	90	BBP 107	1
BBF 308	88	BBP 108	2
BBF 308C	88	BBP 130	1



Numerical Index

Code No	Page No	Code No	Page No
BBT 221	85	BCL 452	87
BBT 232	85	BCL 453	87
BBT 234	85	BCL 454	87
BBT 238	85	BCL 455	87
BBT 239	85	BCL 460	87
BBT 240	85	BCL 461	87
BBT 241	85	BCL 462	87
BCH 301	87	BCL 463	87
BCH 302	87	BCL 464	87
BCH 303	87	BCL 467	87
BCH 304	87	BCL 468	87
BCH 305	87	BCL 469	87
BCH 401	86	BCL 470	87
BCH 401C	86	BCL 474	87
BCH 402	86	BCL 476	87
BCH 402C	86	BCR 234	81
BCH 403	86	BCR 235	81
BCH 403C	86	BCR 236	81
BCH 404	86	BCR 237	81
BCH 404C	86	BCR 238	81
BCH 405	86	BCR 239	81
BCH 405C	86	BCR 240	81
BCH 406	86	BCR 240L	81
BCH 406C	86	BCR 240S	81
BCH 410	86	BCR 241	81
BCH 411	86	BCR 241S	81
BCH 412	86	BCR 242	81
BCH 413	86	BCR 242S	81
BCL 294	87	BCR 243	81
BCL 295	87	BCR 243S	81
BCL 296	87	BCR 244	81
BCL 297	87	BCR 244S	81
BCL 298	87	BCR 245	81
BCL 421	86	BCR 245S	81
BCL 422	86	BCR 246	81
BCL 423	86	BCR 246S	81
BCL 424	86	BCR 247	79
BCL 425	86	BCR 248	79
BCL 426	86	BCR 249	79
BCL 430	86	BCR 250	79
BCL 431	86	BCR 251	79
BCL 432	86	BCR 252	79
BCL 433	86	BCR 253	79
BCL 434	86	BCR 254	79
BCL 435	86	BCR 255	79
BCL 440	86	BCR 256	79
BCL 441	86	BCR 261	79
BCL 442	86	BCR 262	79
BCL 443	86	BCR 263	79
BCL 451	87	BCR 264	79



Numerical Index

Code No	Page No	Code No	Page No
BCR 265	79	BDF 224T	35
BCR 266	79	BDF 225	35
BCR 267	79	BDF 225T	35
BCR 268	79	BDF 228	35
BCR 269	79	BDF 228T	35
BCR 269A	79	BDF 230	35
BCR 270	80	BDF 235	36
BCR 271	80	BDF 235T	36
BCR 272	80	BDF 236	36
BCR 273	80	BDF 236T	36
BCR 274	80	BDF 237	36
BCR 275	80	BDF 237T	36
BCR 276	80	BDF 238	36
BCR 277	80	BDF 238T	36
BCR 278	80	BDF 240	36
BCR 803	79	BDF 240T	36
BCR 817	79	BDF 241	36
BDF 200	34	BDF 241T	36
BDF 200T	34	BDF 242	36
BDF 201	34	BDF 242T	36
BDF 201T	34	BDF 245	36
BDF 202	34	BDF 247	35
BDF 202T	34	BDF 247T	35
BDF 203	34	BDF 250	36
BDF 203T	34	BDF 252	36
BDF 204	34	BDF 253	37
BDF 204T	34	BDF 254	37
BDF 205	34	BDF 257	37
BDF 205T	34	BDF 257T	37
BDF 210	34	BDF 258	37
BDF 210T	34	BDF 258T	37
BDF 211	34	BDF 260	37
BDF 211T	34	BDF 260P	37
BDF 212	34	BDF 262	37
BDF 212T	34	BDF 263	37
BDF 213	34	BDF 265	37
BDF 213T	34	BDF 266	37
BDF 214	34	BDF 267	37
BDF 214T	34	BDL 945	52
BDF 215	34	BDL 950S	52
BDF 215T	34	BDL 970	52
BDF 220	35	BDL 980S	52
BDF 220T	35	BDR 901	50
BDF 221	35	BDR 912	50
BDF 221T	35	BDR 914	50
BDF 222	35	BDR 915	50
BDF 222T	35	BDR 918	50
BDF 223	35	BDS 349	51
BDF 223T	35	BDS 921	51
BDF 224	35	BDS 922	51

Code No	Page No	Code No	Page No
BDS 923	51	BFK 173	93
BDS 924	51	BFK 174	92
BDS 927	51	BFK 175	92
BDS 928	51	BFK 507	95
BEL 157	83	BFK 510	95
BEL 185	82	BFK 511	95
BEL 270	82	BFL 144	96
BEL 272	82	BFL 38	96
BEL 274	82	BFL 44	96
BEL 275	82	BFL 55	96
BEL 276	82	BFL 66	96
BEL 277	82	BFL 68	96
BEL 278	82	BFO 855	97
BEL 279	82	BFO 856	97
BEL 280	84	BFO 857	97
BEL 282	84	BFR 100	97
BEL 283	82	BFR 101	97
BEL 284	84	BFR 102	97
BEL 285	84	BFR 550	58
BEL 290	84	BFR 552	58
BEL 292	84	BFR 555	53
BEL 298	84	BFR 556	53
BEL 299	83	BFR 557	58
BEL 300	83	BFR 558	62
BEL 314	83	BFR 561-L	59
BEL 328	83	BFR 561-M	59
BEL 329	83	BFR 561-S	59
BFD 332	31	BFR 562	59
BFD 79	30	BFR 563-M	59
BFD 80	30	BFR 563-S	59
BFD 81	30	BFR 566	60
BFD 84	30	BFR 567	60
BFD 85	30	BFR 568	60
BFD 86	30	BFR 569	60
BFD 87	30	BFR 570	60
BFD 90	31	BFR 571	60
BFD 92	30	BFR 572	60
BFD 93	31	BFR 573	60
BFD 93C	31	BFR 574	60
BFD 94	30	BFR 575	60
BFD 95	30	BFR 576	60
BFK 117	94	BFR 577	60
BFK 118	94	BFR 578	60
BFK 131	91	BFR 579	60
BFK 160	91	BFR 580	60
BFK 161	91	BFR 581	60
BFK 162	91	BFR 582	60
BFK 170	94	BFR 583	60
BFK 171	94	BFR 584	60
BFK 172	93	BFR 585	60



Numerical Index

Code No	Page No	Code No	Page No
BFR 586	60	BHF 10C	24
BFR 587	62	BHF 12	24
BFR 588	62	BHF 12C	24
BFR 589	62	BHF 13	24
BFR 590	61	BHF 13C	24
BFR 591	61	BHF 15	24
BFR 592	61	BHF 15C	24
BFU 545	66	BHF 16	24
BFU 574	66	BHF 16C	24
BGB 101	66	BHF 17	24
BGB 102	66	BHF 17C	24
BGB 103	66	BHF 18	24
BGB 15	63	BHF 18C	24
BGB 150	66	BHF 19	24
BGB 15C	63	BHF 19C	24
BGB 16	63	BHF 20	24
BGB 16C	63	BHF 20C	24
BGB 18	63	BHF 21	24
BGB 20	63	BHF 21C	24
BGB 22	63	BHF 22	24
BGB 25	63	BHF 22C	24
BGB 27	63	BHF 26	25
BGB 30	64	BHF 26C	25
BGB 31	64	BHF 27	25
BGB 34	64	BHF 27C	25
BGB 35	64	BHF 28	25
BGB 40	64	BHF 28C	25
BGB 43	64	BHF 29	25
BGB 45	64	BHF 29C	25
BGB 50	65	BHF 30	25
BGB 51	65	BHF 30C	25
BGB 52	65	BHF 35	26
BGB 53	65	BHF 35C	26
BGB 58	65	BHF 36	26
BGB 59	65	BHF 36C	26
BGB 60	65	BHF 37	26
BGB 60C	65	BHF 37C	26
BGF 146	32	BHF 38	26
BGF 147	32	BHF 38C	26
BGF 148	32	BHF 39	26
BGF 150	32	BHF 39C	26
BGF 151	32	BHF 40	26
BGF 152	32	BHF 40C	26
BGF 155	32	BHF 45	27
BGF 156	32	BHF 45C	27
BGF 157	32	BHF 47	27
BGF 160	32	BHF 47C	27
BGF 161	32	BHF 48	27
BGF 162	32	BHF 48C	27
BHF 10	24	BHF 50	28



Numerical Index

Code No	Page No	Code No	Page No
BHF 51	28	BLF 62	28
BHF 52	27	BLF 63	28
BHF 52C	27	BLF 64	28
BHF 53	27	BLF 65	28
BHF 53C	27	BLI 870	55
BHO 700	14	BLI 870S	55
BHO 700L	14	BLI 871	55
BHO 705	14	BLI 871S	55
BHO 710	14	BLI 880	55
BHO 710S	14	BLI 881	55
BHY 70T	29	BLI 882	55
BHY 72T	29	BLI 883	55
BHY 73T	29	BLI 885	55
BHY 74T	29	BNH 012	47
BHY 75T	29	BNH 012P	47
BHY 76T	29	BNH 014	47
BIF 132	70	BNH 259	48
BIF 28	69	BNH 383	49
BIF 65	67	BNH 383C	49
BIF 65C	67	BNH 405	45
BIF 68	68	BNH 406	45
BIF 69	68	BNH 407	45
BIF 70	68	BNH 408	45
BIF 73	69	BNH 409	45
BIF 75	69	BNH 412	48
BIF 76	69	BNH 412A	48
BIF 80	70	BNH 416	45
BIF 80C	70	BNH 417	45
BIF 81	70	BNH 418	45
BIF 81C	70	BNH 419	45
BIF 82	70	BNH 422	45
BIF 82C	70	BNH 423	45
BIF 85	71	BNH 424	45
BIF 85C	71	BNH 425	46
BIF 86	72	BNH 426	46
BIF 86C	72	BNH 427	46
BIF 92	72	BNH 428	46
BIF 92C	72	BNH 430	47
BIF 93	71	BNH 435	46
BIF 93C	71	BNH 436	46
BIF 94	70	BNH 437	46
BIF 94C	70	BNH 438	46
BIF 95	71	BNH 442	46
BIF 97	71	BNH 446	46
BIF 97A	71	BNH 447	46
BLF 55	28	BNH 448	46
BLF 56	28	BNH 450	48
BLF 57	28	BNH 451	48
BLF 58	28	BNH 454	47
BLF 61	28	BNH 457	45



Numerical Index

Code No	Page No	Code No	Page No
BNH 458	45	BRP 215	78
BNH 459	45	BRP 216	78
BNH 465	48	BRP 217	78
BNH 470	49	BRP 218	78
BNH 470C	49	BRP 219	78
BNH 471	49	BRP 220	78
BNH 471C	49	BRP 221	78
BNH 472	49	BRP 222	78
BNH 472C	49	BRP 223	78
BNH 478	49	BRP 224	78
BNH 478C	49	BRP 225D	78
BNH 479	49	BRP 225U	78
BNH 479C	49	BRP 226	78
BNH 480	49	BRP 227	78
BNH 480C	49	BRP 227C	78
BNH 482	49	BRT 478	20
BNH 482C	49	BRT 712	15
BNH 812	47	BRT 712S	15
BOM 817	108	BRT 714	15
BOM 818	108	BRT 714S	15
BOM 819	108	BRT 716	15
BOM 820	108	BRT 716S	15
BOM 826	108	BRT 720	15
BOM 866	106	BRT 721	16
BOM 867	106	BRT 722	16
BOM 869	106	BRT 723	15
BOM 870	107	BRT 725	16
BOM 871	107	BRT 725S	16
BOM 876	108	BRT 726	16
BOM 879	109	BRT 726S	16
BPR 822	50	BRT 727	16
BPR 823	50	BRT 727S	16
BPR 824	50	BRT 738	18
BPR 825	50	BRT 739	18
BPR 826	50	BRT 740	18
BPR 827	50	BRT 742	18
BPR 828	50	BRT 743	18
BRP 175	77	BRT 744	18
BRP 175C	77	BRT 745	18
BRP 177	77	BRT 746	18
BRP 177C	77	BRT 747	18
BRP 180	77	BRT 748	20
BRP 181	77	BRT 749	20
BRP 182	77	BRT 749A	20
BRP 183	77	BRT 750	18
BRP 184	77	BRT 752	19
BRP 185	82	BRT 753	19
BRP 212	78	BRT 754	19
BRP 213	78	BRT 755	19
BRP 214	78	BRT 756	19



Numerical Index

Code No	Page No	Code No	Page No
BNH 458	45	BRP 215	78
BNH 459	45	BRP 216	78
BNH 465	48	BRP 217	78
BNH 470	49	BRP 218	78
BNH 470C	49	BRP 219	78
BNH 471	49	BRP 220	78
BNH 471C	49	BRP 221	78
BNH 472	49	BRP 222	78
BNH 472C	49	BRP 223	78
BNH 478	49	BRP 224	78
BNH 478C	49	BRP 225D	78
BNH 479	49	BRP 225U	78
BNH 479C	49	BRP 226	78
BNH 480	49	BRP 227	78
BNH 480C	49	BRP 227C	78
BNH 482	49	BRT 478	20
BNH 482C	49	BRT 712	15
BNH 812	47	BRT 712S	15
BOM 817	108	BRT 714	15
BOM 818	108	BRT 714S	15
BOM 819	108	BRT 716	15
BOM 820	108	BRT 716S	15
BOM 826	108	BRT 720	15
BOM 866	106	BRT 721	16
BOM 867	106	BRT 722	16
BOM 869	106	BRT 723	15
BOM 870	107	BRT 725	16
BOM 871	107	BRT 725S	16
BOM 876	108	BRT 726	16
BOM 879	109	BRT 726S	16
BPR 822	50	BRT 727	16
BPR 823	50	BRT 727S	16
BPR 824	50	BRT 738	18
BPR 825	50	BRT 739	18
BPR 826	50	BRT 740	18
BPR 827	50	BRT 742	18
BPR 828	50	BRT 743	18
BRP 175	77	BRT 744	18
BRP 175C	77	BRT 745	18
BRP 177	77	BRT 746	18
BRP 177C	77	BRT 747	18
BRP 180	77	BRT 748	20
BRP 181	77	BRT 749	20
BRP 182	77	BRT 749A	20
BRP 183	77	BRT 750	18
BRP 184	77	BRT 752	19
BRP 185	82	BRT 753	19
BRP 212	78	BRT 754	19
BRP 213	78	BRT 755	19
BRP 214	78	BRT 756	19



Numerical Index

Code No	Page No	Code No	Page No
BRT 757	21	BSC 306C	40
BRT 758	20	BSC 307	39
BRT 759	20	BSC 307C	39
BRT 762	21	BSC 308	39
BRT 763	21	BSC 308C	39
BRT 765	21	BSC 309	39
BRT 766	21	BSC 309C	39
BRT 767	21	BSC 310	38
BRT 770	21	BSC 312	38
BRT 771	21	BSC 313	38
BRT 772	21	BSC 315	41
BRT 780	22	BSC 315A	41
BRT 781	22	BSC 317	40
BRT 782	22	BSC 318	40
BRT 785	23	BSC 319	40
BRT 786	23	BSC 322	38
BRT 788	22	BSC 322C	38
BRT 790	23	BSC 325	41
BRT 791	23	BSC 326	41
BRT 792	23	BSC 327	41
BRT 793	23	BSC 328	41
BRT 794	23	BSC 330	42
BRT 795	23	BSC 330C	42
BRT 800	17	BSC 331	42
BRT 800S	17	BSC 331C	42
BRT 801	17	BSC 332	42
BRT 801S	17	BSC 332C	42
BRT 802	17	BSC 333	42
BRT 802S	17	BSC 333C	42
BRT 803	17	BSC 334	42
BRT 803S	17	BSC 334C	42
BRT 804	17	BSC 335	42
BRT 804S	17	BSC 335C	42
BRT 852	19	BSC 338	38
BRT 853	19	BSC 338C	38
BRT 854	19	BSC 339	44
BRT 856	19	BSC 340	43
BRT 862	19	BSC 340C	43
BRT 863	19	BSC 341	43
BSC 301	39	BSC 341C	43
BSC 301C	39	BSC 342	43
BSC 302	39	BSC 342C	43
BSC 302C	39	BSC 343	43
BSC 303	39	BSC 343C	43
BSC 303C	39	BSC 344	43
BSC 304	40	BSC 344C	43
BSC 304C	40	BSC 345	43
BSC 305	40	BSC 345C	43
BSC 305C	40	BSC 352	44
BSC 306	40	BSC 353	44



Numerical Index

Code No	Page No	Code No	Page No
BSC 354	44	BTR 520	56
BSC 360	44	BTR 520L	56
BSC 360C	44	BTR 520M	56
BSC 361	44	BTR 520S	56
BSC 361C	44	BWP 131	106
BSC 365	44	BWP 135	106
BSC 365C	44	BWP 170	106
BSC 366	44	BWP 171	106
BSC 366C	44	BWP 172	106
BSC 390	44	GLAST 01	57
BSK 170	105	GLAST 02	57
BSK 172	105	GLAST 03	57
BSK 173	105	GLAST 04	57
BSR 073	8	GLAST 05	57
BSR 154	10	GIFST 01	57
BSR 190	9	GIFST 02	57
BSR 191	9	GIFST 03	57
BSR 650	7	GIFST 04	57
BSR 660	7	GIFST 05	57
BSR 670	8	GIPSTC (BST532C)CVD	57
BSR 672	8	GIPSTS (BST 532)STR	57
BSR 672S	8	GIYST (BST 530)	57
BSR 673	8	PGR 405	110
BSR 673S	8	PGR 405C	110
BSR 674	10	PGR 406	110
BSR 675	10	PGR 406C	110
BSR 675S	10	PGR 407	110
BSR 676	9	PGR 407C	110
BSR 677	10	PGR 408	110
BSR 678	9	PGR 408C	110
BSR 680	11	PGR 409	110
BSR 680S	11	PGR 409C	110
BSR 682	11	PGR 410	110
BSR 682S	11	PGR 410C	110
BSR 685	12	PGR 411	110
BSR 685S	12	PGR 411C	110
BSR 690	13	PGR 412	110
BTC 170	33	PGR 412C	110
BTC 172	33	SCM	108
BTC 174	33		
BTC 175	33		
BTC 176	33		
BTC 177	33		
BTC 184	33		
BTC 185	33		
BTC 188	33		
BTC 189	33		
BTC 190	33		
BTR 126	56		
BTR 510	56		